

# DATASHEET AND OPERATING GUIDE

# PWRPAK 16 A / 5 V

## Switched Mode Power Supply



### FEATURES & BENEFITS

- 80 W
- Compact footprint
- Universal input (88-264 VAC / 125-373 VDC)
- Over voltage, over load, and short circuit protections
- UL/cUL and TUV safety approvals
- Long life electrolytic capacitors
- No load power consumption < 0.5 W
- Ripple and noise 100 mVp-p
- 80% Efficiency

### USED WITH

- LD15CHA Laser Diode Driver

### SMALL SIZE, EFFICIENT

Wavelength offers the PWRPAK-16A-5V low noise switched power supply for the LD15CHA Laser Diode Driver. It provides 16 A output current at 80% efficiency.

One of the most important components affecting noise performance is the power supply used to power the laser driver. A linear supply will offer lower noise, but a much larger size and lower efficiency.

### SIMPLE POWER CONNECTIONS

This PWRPAK offers enough current and voltage to operate the LD15CHA in single supply operation. It has a 5 V output to power the control electronics and provide up to 3 V to the laser. The 16 A current output covers the entire current range of LD15CHA models. An additional wiring kit (WCB325) makes connections easy.

### CONTENTS

	PAGE
QUICK CONNECT GUIDE	2
PERFORMANCE SPECIFICATIONS	3
MECHANICAL SPECIFICATIONS	5
CERTIFICATION AND WARRANTY	6

### ORDERING INFORMATION

PART NO	DESCRIPTION
PWRPAK-16A-5V	16 A / 5 V Switched Power Supply
WCB325	Power Supply Wiring Kit

## QUICK CONNECT GUIDE



TO DETERMINE IF THE PWRPAK-16A-5V POWER SUPPLY IS APPROPRIATE FOR YOUR APPLICATION, IT IS IMPERATIVE THAT YOU VERIFY THE UNIT WILL BE OPERATING WITHIN THE INTERNAL HEAT DISSIPATION SAFE OPERATING AREA (SOA).

Visit the Wavelength Electronics website for the most accurate, up-to-date, and easy to use SOA calculator.

The SOA calculator for Laser Diode Drivers is at this page: [www.teamwavelength.com/support/design-tools/soa-ld-calculator/](http://www.teamwavelength.com/support/design-tools/soa-ld-calculator/) then choose the LD15CHA driver.

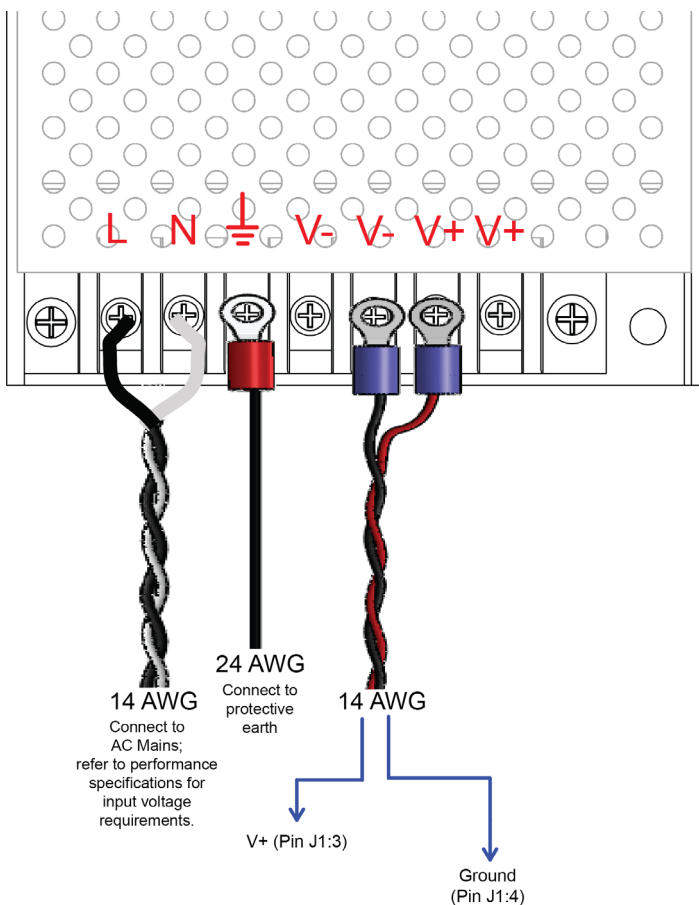

Figure 1. Power Supply Wiring Diagram using WCB325

## WIRING THE PWRPAK-16A-5V

Figure 1 illustrates the power supply connections for single supply operation:

- V+** — positive output terminal
- V-** — negative output terminal (system ground)
- GND** — frame ground (protective earth)
- L** — live line input terminal (fuse in line)
- N** — neutral line input terminal

## WIRING POWER SUPPLY TO LD15CHA DRIVER

Follow these instructions to wire the power supply using the WCB325 Power Cable. Refer to Figure 1.

- 24 AWG black wire, 10" with red ring lug at one end. Attach the ring lug to the GND terminal of the power supply. Attach the other end to AC protective earth.
- 14 AWG black and white twisted pair wire, 24" with stripped ends. The black wire is connected to the live line input terminal on the power supply (L). The white wire is connected to the neutral input terminal on the power supply (N). The other end of the wires is connected to AC Mains.
- 14 AWG red and black twisted pair wire, 24" with two blue ring lugs at one end. Attach the ring lug on the red wire to the V+ terminal of the power supply. Connect the other end to V+ on the LD15CHA. Connect the ring lug on the black wire to the V- terminal of the power supply. Connect the other end of the black wire to GND on the LD15CHA.

## PERFORMANCE SPECIFICATIONS

PARAMETER DESCRIPTION	PARAMETER VALUE	NOTES
<b>INPUT</b>		
Input Voltage Range	88 - 264 VAC 125 - 373 VDC	
Frequency	50 - 60 Hz	
Inrush Current	40 A	At 230 VAC, full load, cold start
<b>OUTPUT</b>		
Output Power Maximum	80 W	
Output Voltage	5 V	Output voltage is within $\pm 2\%$ of nominal output voltage
Output Current	16 A	
Leakage Current	2 mA	Measured per IEC 60950-1, paragraph 5.1, test voltage of 240 VAC/60 Hz
Hold Up Time	10 ms 32 ms	At 115 VAC, cold start At 230 VAC, cold start
Line Regulation	$\pm 0.5\%$	Low line to high line
Load Regulation	$\pm 1.0\%$	
Ripple & Noise	$\leq 100$ mVp-p	
Overvoltage Protection	115 - 150%	Latch off mode
Overload Protection	$\leq 110\%$	Hiccup mode, auto recovery
Temperature Coefficient	0.3% / °C	0 - 50°C
<b>GENERAL</b>		
Efficiency	80%	
MTBF	620,300 hours	At 230 Vac, MIL-HDBK-217F 25°C ambient
Operating Temperature <sup>(1)</sup>	-20 to +70 °C	See derating chart for operation above 50°C
<b>EMC</b>		
EN 55022 : 1998+A1 : 2000+A2 : 2003 Class B, EN 61000-3-2 : 2000+A2 : 2005 Class A, EN 61000-3-3 : 1995+A1 : 2001, EN 61204-3 : 2000 EN 50204 1998+A1 : 2001+A2 : 2003 light industry level, criteria A	Yes	
<b>SAFETY</b>		
UL 60950-1 / TUV EN 60950-1	Yes	
Size	5.1" x 3.9" x 1.5" 129.5 x 97.5 x 37.5 mm	

<sup>(1)</sup> Derating information can be found in **Table 1 on page 4**.

## OUTPUT DERATING

**Figure 2** shows the output load versus temperature derating for the PWRPAK-16A-5V.

**Table 1** shows the output available at different ambient temperatures as a percent of full current.

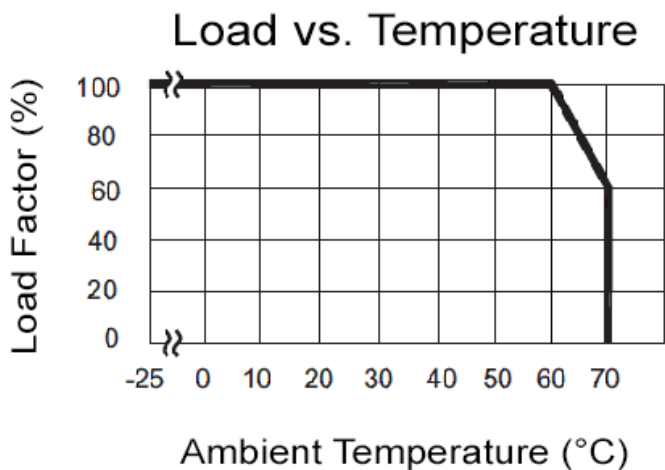

Figure 2. Load vs. Temperature Derating Curve

Table 1. Derating Chart

AMBIENT TEMPERATURE	MOUNTING METHOD	
	A	B
-25 to +60 °C	100	100
65°C	80	80
70°C	60	60
75°C	0	0

**Figure 3** shows the output load versus voltage for the PWRPAK-16A-5V.

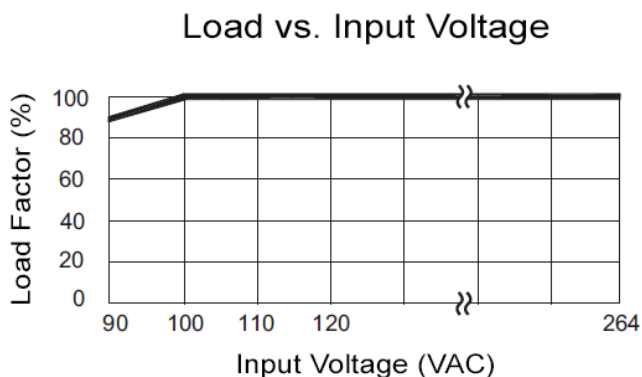

Figure 3. Load vs Input Voltage Derating Curve

## MOUNTING CONSIDERATIONS

**Figure 4** shows various mounting configurations. The standard method (A) is recommended. Configuration B also works. Do not use configuration C, where the PCB is on the top and heat is trapped within the unit.

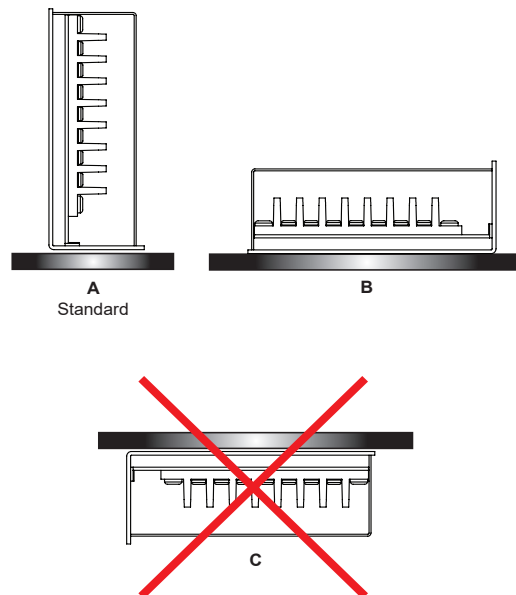

Figure 4. Mounting Options

- This is a convection cooling type power supply. To ensure proper heat radiation and safety, allow a distance of more than 15 mm between the power supply and peripheral parts. See **Figure 5**.
- The maximum allowable penetration of mounting screws is 6 mm.
- Recommended torque for the mounting screw is 0.49 N·m (5.0 kgf·cm).

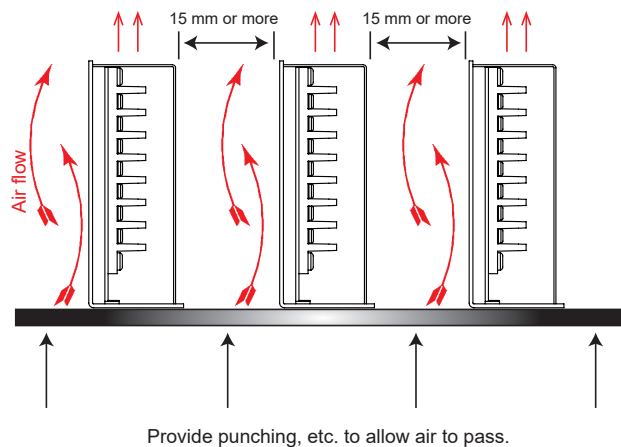

Figure 5. Airflow Requirements

# MECHANICAL SPECIFICATIONS

Note:  
terminal block screws #6-32 (7 PLCS)

Tolerance:  $\pm 0.3\text{mm}$  unless otherwise specified

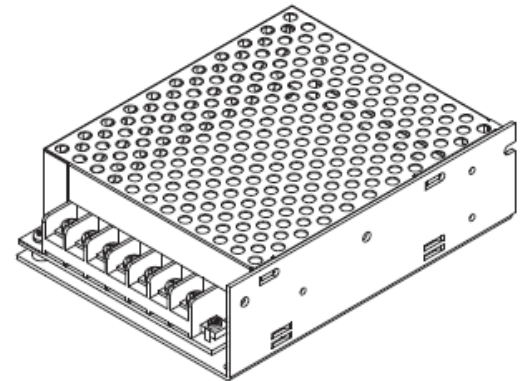
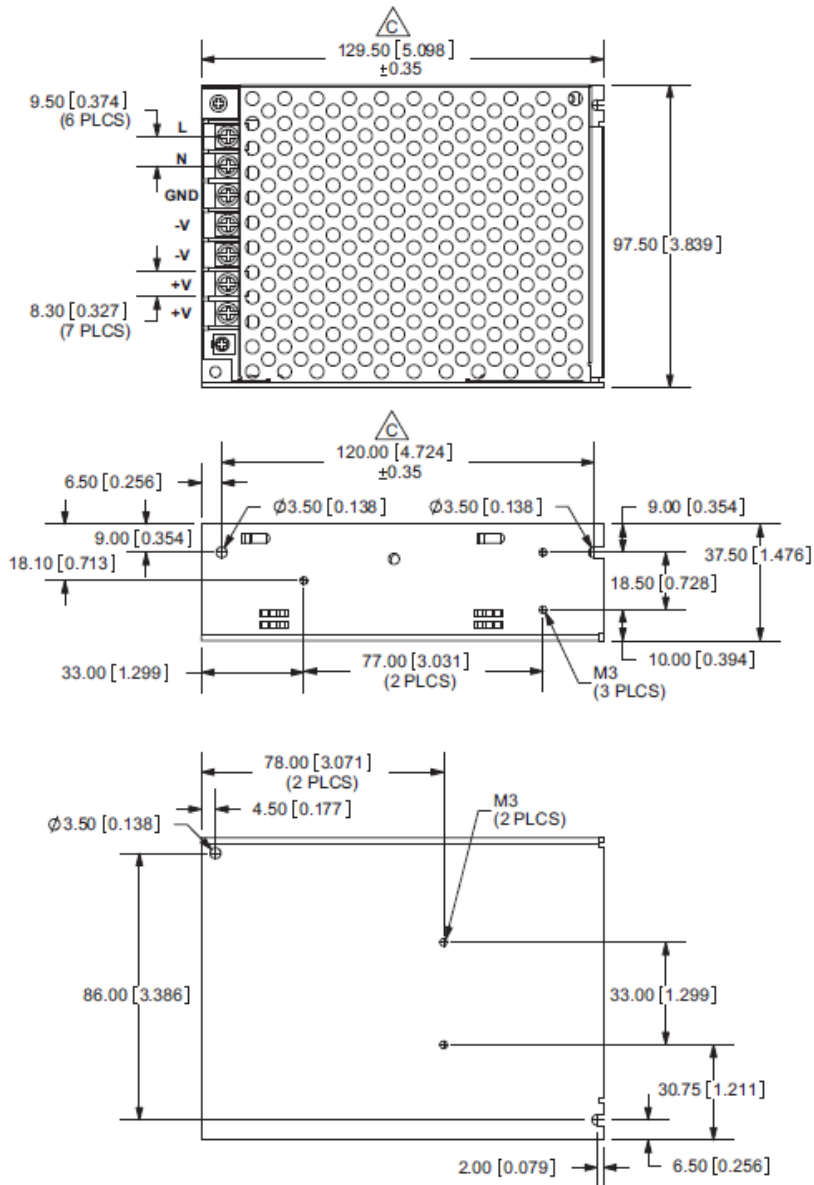

Diagram courtesy of CUI Inc. Specifications subject to change.

## CERTIFICATION AND WARRANTY

### CERTIFICATION

Wavelength Electronics, Inc. (Wavelength) certifies that this product met its published specifications at the time of shipment. Wavelength further certifies that its calibration measurements are traceable to the United States National Institute of Standards and Technology, to the extent allowed by that organization's calibration facilities, and to the calibration facilities of other International Standards Organization members.

### WARRANTY

This Wavelength product is warranted against defects in materials and workmanship for a period of one (1) year from date of shipment. During the warranty period, Wavelength will, at its option, either repair or replace products which prove to be defective.

### WARRANTY SERVICE

For warranty service or repair, this product must be returned to the factory. An RMA is required for products returned to Wavelength for warranty service. The Buyer shall prepay shipping charges to Wavelength and Wavelength shall pay shipping charges to return the product to the Buyer upon determination of defective materials or workmanship. However, the Buyer shall pay all shipping charges, duties, and taxes for products returned to Wavelength from another country.

### LIMITATIONS OF WARRANTY

The warranty shall not apply to defects resulting from improper use or misuse of the product or operation outside published specifications. No other warranty is expressed or implied. Wavelength specifically disclaims the implied warranties of merchantability and fitness for a particular purpose.

### EXCLUSIVE REMEDIES

The remedies provided herein are the Buyer's sole and exclusive remedies. Wavelength shall not be liable for any direct, indirect, special, incidental, or consequential damages, whether based on contract, tort, or any other legal theory.

### REVERSE ENGINEERING PROHIBITED

Buyer, End-User, or Third-Party Reseller are expressly prohibited from reverse engineering, decompiling, or disassembling this product.

### NOTICE

The information contained in this document is subject to change without notice. Wavelength will not be liable for errors contained herein or for incidental or consequential damages in connection with the furnishing, performance, or use of this material. No part of this document may be translated to another language without the prior written consent of Wavelength.

## SAFETY

There are no other user-serviceable parts inside this product. Return the product to Wavelength for service and repair to ensure that safety features are maintained.

## LIFE SUPPORT POLICY

This important safety information applies to all Wavelength electrical and electronic products and accessories:

As a general policy, Wavelength Electronics, Inc. does not recommend the use of any of its products in life support applications where the failure or malfunction of the Wavelength product can be reasonably expected to cause failure of the life support device or to significantly affect its safety or effectiveness. Wavelength will not knowingly sell its products for use in such applications unless it receives written assurances satisfactory to Wavelength that the risks of injury or damage have been minimized, the customer assumes all such risks, and there is no product liability for Wavelength. Examples of devices considered to be life support devices are neonatal oxygen analyzers, nerve stimulators (for any use), auto-transfusion devices, blood pumps, defibrillators, arrhythmia detectors and alarms, pacemakers, hemodialysis systems, peritoneal dialysis systems, ventilators of all types, and infusion pumps as well as other devices designated as "critical" by the FDA. The above are representative examples only and are not intended to be conclusive or exclusive of any other life support device.

## REVISION HISTORY

DOCUMENT NUMBER: PWRPAK-00404

REV.	DATE	CHANGE
A	March 2018	Initial Release



51 Evergreen Drive  
Bozeman, Montana 59715

406-587-4910 (tel)  
406-587-4911 (fax)

Sales & Tech Support  
[sales@teamwavelength.com](mailto:sales@teamwavelength.com)  
[techsupport@teamwavelength.com](mailto:techsupport@teamwavelength.com)

