

USER GUIDE

Laboratory Series High Precision Temperature Controller — with IntelliTune[®]



CONTENTS

ORDERING INFORMATION	1
GENERAL OVERVIEW	2
SAFETY	3
QUICK CONNECT GUIDE	4
PIN DESCRIPTIONS	6
ELECTRICAL SPECIFICATIONS	7
OPERATING INSTRUCTIONS	8
TROUBLESHOOTING	20
ERROR MESSAGES	23
TC LAB MECHANICAL SPECIFICATIONS	24
CABLING SPECIFICATIONS	25
WARRANTY & CERTIFICATION	29

ORDERING INFORMATION

PART NO	DESCRIPTION
TC10 LAB	10 A, 15 V Temperature Controller Instrument
TC15 LAB	15 A, 20 V Temperature Controller Instrument
TC/SENSOR MATING D-SUB	One included with each instrument
RCKMT-LAB SNGL	19" Single Unit Rack Mount Kit
RCKMT-LAB DUAL	19" Dual Unit Rack Mount Kit
THERMISTORS	Various Thermistors Available
CKT-203	Status/Enable Male DB-9 Connector Kit
CKT-204	TE/RH/Sensor Male DB 15+2 Connector Kit
WCB405	Status/Enable DB-9 Cable Assembly
WCB406	TE/RH/Sensor DB 15+2 Cable Assembly
WCB315	LDMOUNT Cable for TC LAB Series
WCB319	LDMOUNT Cable for TC LAB Series (no lock)



Applies to Product Revision A-D, firmware version 1.99 and 2.01 and above
© February 2024

GENERAL OVERVIEW

FEATURES

- Two models: 10 A and 15 A output current
- Compliance voltages of 15 V (TC10) and 20 V (TC15)
- Stability better than 0.0009°C with thermistor
- Compatible with a variety of sensors
 - » Thermistors
 - » 2, 3, or 4-wire RTDs
 - » Linear voltage sensors
 - » Linear current sensors
- Touchscreen with intuitive user interface
- Safety features protect your research
 - » Adjustable current limit, with Brick-Wall Never-Exceed circuitry
 - » Password protection available to lock out a selectable control set
 - » Over-temperature protection circuit
 - » Temperature limits on the load
 - » Shutdown signal to the QCL/laser driver load to protect against over- or under-temperature situations.
- IntelliTune sets ideal PID control parameters for optimal time to temperature or fast disturbance rejection
- Complete command set for remote control from computer
- LabVIEW® Virtual Instrument, USB and Ethernet interfaces
- Auxiliary input for heatsink sensor
- Feature-rich for research projects
- Automatic temperature scan function
- Data collection using a computer or USB flash drive
- Field upgradeable firmware
- Sophisticated error handling
- Save and recall functions for specific parameter sets
- CE compliant
- All instrument documentation and software are provided on a USB flash drive
- Optional rack mount kit: 2 U height, ½ rack width
- AC input, auto detect, 100-240 VAC, ±15%, 50-60 Hz power-line frequency

LabVIEW is a trademark of National Instruments.

ULTRA-STABLE TEMPERATURE CONTROLLER

The TC LAB series of temperature controllers integrates high-end digital control with a precision output current drive stage to offer the best stability temperature control instrument commercially available today. Many different sensors can be used in the feedback loop including thermistors, RTDs, linear current and linear voltage sensors.

Two models are available driving 10 A or 15 A maximum with 15 V (20 V for TC15) compliance to the thermoelectric or resistive heater.

Safety features protect the thermoelectric [TE] and its load. Over- and under-temperature limits as well as positive and negative current limits can be set. If the sensor signal is lost or a short is detected at the TE, output current is disabled. If temperature limits are exceeded, TE current is disabled and a signal to the active load can be sent to disable its current. For example, connect the LD Shutdown BNC output to the Active Lock input on Wavelength's QCL LAB driver and the QCL current will shut down if temperature limits are exceeded. An Auxiliary Sensor can be used to monitor the temperature of the system heatsink.

INTUITIVE USER INTERFACE AND SUPERIOR REMOTE CONTROL

With Wavelength's plug and play instrument, you have the ability to quickly set the controls using either the instrument touchscreen or a remote computer.

INTELLITUNE: INTELLIGENT AUTOTUNE

Wavelength's proprietary IntelliTune algorithm characterizes the TE/sensor system's response to the controller and determines the optimal PID control coefficients. **It then automatically adjusts the PID control values as setpoint, tuning mode, or bias current change.**

Run IntelliTune easily just off ambient and watch it change PID settings for a much higher or lower setpoint. After a single scan, explore either optimized Setpoint Response or Disturbance Rejection performance with your load to see which works best. Add or remove the D term to see if noise is an issue. IntelliTune lets you skip the manual characterization and it's smart enough to really work—very little adjustment is needed after you have stored a successful characterization scan. See Application Note [AN-TC13](#) for an in depth exploration.



APPLICATIONS

The advanced and reliable circuitry of the TC LAB Series instruments achieve better than 0.0009°C temperature stability with thermistors.



The ultra-stable temperature controller instruments are particularly reliable for diverse fields such as medical, defense, communications and manufacturing. Applications include particle and droplet measurement, communications, manufacturing test, and medical systems. Additionally, our products are designed for use with electro-optical systems, airborne instrumentation, spectroscopic monitors, and medical diagnostic equipment.

SAFETY





DEFINITIONS

	CHASSIS GROUND Symbol
	CAUTION: A condition that has the potential to cause damage to property or instrument.
	WARNING: A condition that has the potential to cause bodily harm or death.

CAUTIONS

	The TC LAB instrument has no user-serviceable parts. Other than the fuses, the TC LAB instrument is not designed to be maintained by the user nor does it contain any parts that can be repaired by the user. All maintenance and repairs must be performed by Wavelength or the warranty will be void.
	Use a soft cloth to remove dust from the TC LAB instrument. Do not expose the TC LAB instrument to any liquids, sprays, or solvents. To avoid electrical shock, unplug the power cord before cleaning the instrument.
	Before connecting to the power source, make sure the correct cables for your area are set.

WARNINGS

	Position the TC LAB instrument so that access to the Main Power On/Off switch on the back panel is easily accessed.
	Do not use the TC LAB instrument if there is evidence of damage from shipping; damaged equipment can present significant safety hazards. If you suspect the TC LAB instrument is damaged, contact Wavelength technical support before attempting to operate the instrument.
	To avoid electrical shock, use the recommended earth-grounded power cables and properly earth-grounded, 3-prong receptacles only. Failure to follow this precaution can result in severe injury.
	The instrument may not be operated at measuring category II, III, and IV mains power circuits. In accordance with EN 601010-1:2010, the instrument has been designed without a rated measuring category and may only be used at direct voltage circuits with up to 240 VAC without transient overvoltages Operating safety is no longer assured in the event of modification or alteration. The instrument may only be opened by authorized service technicians. Never operate the instrument at a higher voltage than specified in the technical data. The instrument may otherwise be destroyed or permanently damaged.
	To avoid injury, do not tell the engineers how to do their jobs. Let them muddle through until they decide to read the User Guide.

GENERAL

- Observe all Cautions and Warnings both in the User Guide and on the instrument.
- This instrument is designed to be safe to at least the following conditions: indoor use, 6500 ft (2000 m), 80% max. relative humidity for temperatures up to 31°C and decreasing linearly to 50% relative humidity at 40°C, transient overvoltages to Overvoltage Category 2, and environmental conditions to Pollution Degree 2.
- Use the TC LAB instrument as specified in this guide. If not, the protection provided by this instrument may be impaired and the warranty will be voided.
- The TC LAB instrument is intended to be used to control thermoelectrics, resistive heaters, and other similar equipment. Please contact Wavelength Electronics for other possible applications.
- The TC LAB instrument must not be operated in explosion endangered environments.
- Do not operate the TC LAB instrument where liquids are present or used and do not spill liquid on the instrument.
- The safety of any system that incorporates the use of the TC LAB series instrument is the sole responsibility of the system assembler. This includes assembly, mounting, location, special ambient or application conditions, and connections within the system.
- Operating outside of the conditions specified in the User Guide are not recommended for safety reasons.
- Proper setup in the end user's environment includes:
 - » Adequately sized thermoelectric and heatsink to properly manage the heat dissipated by the load.
 - » Securely mounted temperature sensor for accurate temperature control.
 - » Correct connection of the thermoelectric.
 - » Use of the LD Shutdown connection to protect the load.

POWER CORDS

- The power cord acts as the power disconnecting device between the AC mains and TC LAB instrument.
- This equipment is grounded through the AC power cord grounding conductor.
- Use only the earth-grounded power cords that are recommended in this user guide.
- Route power cords and other cables so that they cannot be damaged.
- Position the TC LAB instrument in a location that makes it easy to quickly disconnect the power cord.
- To avoid fire hazard, use only the specified power cords with the correct grounding, voltage, and current ratings.

FUSES

- Disconnect the power to the TC LAB instrument before changing the fuses.
- To prevent damage to the TC LAB instrument when replacing fuses, locate and correct the problem that caused the fuse to blow before re-applying power.
- To avoid fire hazard, use only the specified fuse with the correct type number, voltage, and current ratings, and use only the recommended replacement parts.

QUICK CONNECT GUIDE

CONNECT THE POWER

On the back panel, insert the female end of the IEC AC power cable into the Power receptacle and then plug the male end into the AC power source.

NOTE: Place the TC LAB instrument at least 6" away from any wall to provide adequate ventilation and prevent overheating.

WIRE A TEST LOAD

We recommend using a test load and simulated thermistor when configuring the TC LAB instrument. The thermistor test load simulates a 10 kΩ thermistor operating at 25°C.

Wire a test load to a 15 + 2 D-SUB plug and insert the plug into the **TE Out and Sensor D-SUB** port located on the back panel.

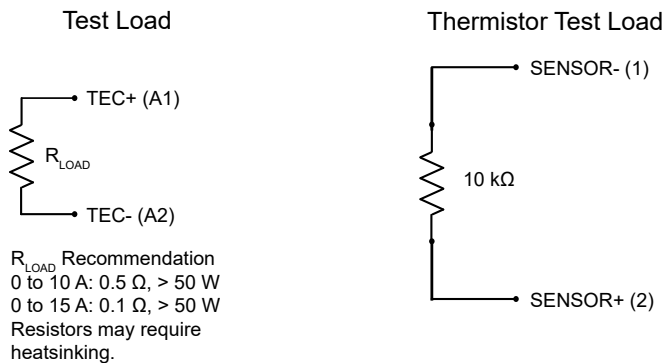

Figure 1. Test Load Wiring Schematic

Setting up this test load allows current to be driven to either the positive or negative limit. Choose units of resistance and change the setpoint above or below the 10 kΩ value. This confirms proper operation and direction of the current flow.

TURN ON POWER

1. Press the **Power** switch on the back panel to the | position. The front panel power button light slowly pulses.
2. Press the **Power** button on the front panel, the button illuminates, touchscreen is activated, and the Control Screen is active.

*NOTE: Turning off front **Power** button powers down the application electronics and puts the unit into Standby mode. Turning off rear **Power** switch powers down all electronics and some settings return to factory default.*

SET THE LIMITS



1. Press to access the Limit Screen.
2. On the Limit Screen, press the blue **Limit Current** values and rotate the adjustment knob to change to the desired values. The instrument will beep when set.

Temperature limits can be set on this screen. The setpoint is restricted by these limits.

The positive and negative current settings indicate the direction of flow during heating and cooling.

CHOOSE A CONTROL SENSOR



1. Press to access the Sensor Screen.
2. Press the **Sensor Type** value and turn the adjustment knob to cycle through the factory defaults or any user-defined sensors.

Choose the sensor to match the test load or the appropriate sensor for the test load. Additionally, thermistors require choosing the correct bias current.

The test load suggested by Wavelength uses a 10 kΩ 100 μA thermistor configuration.

ADJUST SETPOINT



1. Press to access the Control Screen.
2. Press the blue **Setpoint** temperature value and turn the adjustment knob to change it. The instrument will beep when set.

NOTE: The Control Screen is on by default when the instrument is turned on.

The Control Screen is also the location of the PID control parameters, IntelliTune (intelligent autotune), and the Temperature Scan function. To change any of the PID values, press the number and turn the adjustment knob until the desired value is displayed.

ENABLE CURRENT

Press the **Enable** button. There is no delay before the button illuminates and the current flows.

SHUTDOWN THE INSTRUMENT

If the Enable button is illuminated, current is still flowing to the test load. Before shutting down, the current needs to be turned off.

1. Press the **Enable** button. The button light will turn off and current to the test load will stop.
2. On the front panel, press the **Power** button. The touchscreen will go black but the button light slowly pulses blue to indicate that the back Power button is still on.

*NOTE: Turning off only the front **Power** button puts the instrument in Standby mode.*

3. On the back panel, press the **Power** switch to the **O** position. The instrument will shut down.

PIN DESCRIPTIONS

STATUS / ENABLE D-SUB

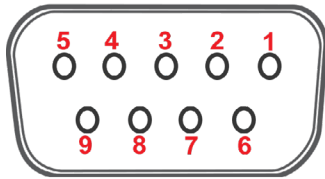

Figure 2. Female 9-Pin D-SUB

THERMOELECTRIC / RESISTIVE HEATER AND SENSOR D-SUB

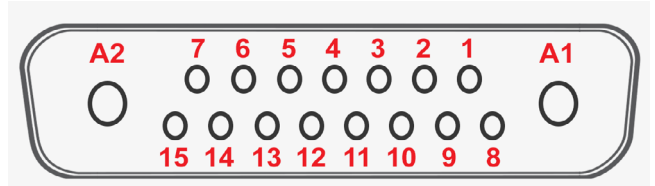

Figure 4. Female 15+2 D-SUB

Table 1. Status/Enable D-SUB Pin description

PIN	DESCRIPTION
1	Remote Enable Input (IN)
2	Remote Enable Ground (GND)
3	Not Connected
4	Not Connected
5	Status Ground (GND)
6	Enable Status
7	At Temperature Status
8	Fan Driver Output (OUT)
9	Fan Ground (GND)
SHELL	Chassis Ground

Table 2. TE or RH and Sensor D-SUB Pin Description

PIN	DESCRIPTION
1	Thermistor - (negative)
2	Thermistor + (positive)
3	IC Sensor (AD590- or LM335+)
4	IC Sensor (AD590+ or LM335-)
5	Not Connected
6	Not Connected
7	Not Connected
8	RTD Force -
9	RTD 2/3 Wire Sense -
10	RTD 2/3 Wire Sense +
11	RTD 4 Wire Sense -
12	RTD 4 Wire Sense +
13	RTD Force +
14	Auxiliary Sensor -
15	Auxiliary Sensor +
A1	TEC Output +
A2	TEC Output -

SHUTDOWN OUTPUT SIGNAL TO LASER DRIVER OR QCL

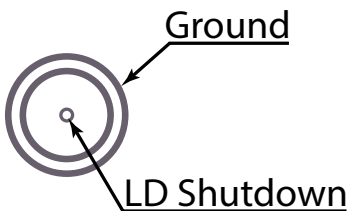

Figure 3. LD Shutdown BNC Pins

ELECTRICAL SPECIFICATIONS

OUTPUT	MIN	TYP	MAX	UNITS	NOTES
Output Current	10 or 15			A	10 A for TC10, 15 A for TC15
Short Term Stability, 1 hour, Off Ambient ^{1,2}	0.0002	0.0006		°C	25°C ambient
Short Term Stability, 1 hour, On Ambient ^{1,2}	0.0003	0.0009		°C	25°C ambient
Long Term Stability, 24 hour, Off Ambient ^{1,2}	0.00067	0.002		°C	25°C ambient
Temperature Coefficient	5	10	18	ppm / °C	
Compliance Voltage Range	0-15 or 0-20			V	≤15 V for TC10. ≤20 V for TC15.

SENSOR COMPATIBILITY	VALUE	NOTES
NTC Thermistor Sensor Range Voltage	0 - 10 V	
NTC Thermistor Bias Current Range	10 µA - 10 mA	Auto-ranging bias current ³
2,3,4 Wire RTD Sensor Range	100 Ω - 1 kΩ	
Linear Voltage or Current Sensors	Supported	Comparable to LM335 and AD590
Bias Current Accuracy	0.004%	
Bias Current Temperature Coefficient	10 ppm/°C	

POWER SUPPLY REQUIREMENTS	VALUE	NOTES
AC Power Supply and Line Frequency	100-240 VAC (± 10%), 3 A, 50-60 Hz	
Fuse for 100-240 V	3.15 A 250 AC Fast Blow (3.15 AH 250 V 5×20 mm)	Replacement fuse: Littelfuse 02163.15 HXP
Max AC Line Power	200 W	

FEEDBACK LOOP: Proportional / Integral / Derivative (PID)

GENERAL SPECIFICATIONS	VALUE	NOTES
Warm-up Time	1 Hour	
Remote Interface	USB, Ethernet	
Warranty	One (1) Year	
Safety Tested To	IEC 61000-3-2 IEC 61000-3-3 IEC 61000-4-2 IEC 61000-4-3 IEC 61000-4-4	IEC 61000-4-5 IEC 61000-4-6 IEC 61000-4-8 IEC 61010-1 EN61010-2-30
		European Council Directive 2004/108/EC & European Council Directive 2006/95/EC

ABSOLUTE MAXIMUM RATINGS	VALUE	UNIT	NOTES
Case Operating Temperature Range	0 to 40	°C	
Weight	7.4 (3.36)	lbs (kg)	
Size	3.47 × 8.86 × 17.72 (89 × 226 × 450)	inches (mm)	
Case Storage Temperature	-40 to 70	°C	
Humidity	80	%	Relative humidity at 30°C, non-condensing

¹ This specification assumes a steady-state operation with a tuned system using a 10 kΩ thermistor. Minimum Stability achieved by measuring 1 standard deviation (1σ) away from the mean. Typical Stability achieved by measuring 3 standard deviations (3σ) away from the mean. For more detail, see [TN-TC02](#). Stability typical for a 14 pin butterfly package laser diode with a 10 kΩ thermistor.

Stability will vary with different load types, thermal designs, and sensors. RTDs and linear voltage and current sensors are much less sensitive than thermistors to temperature change, so stability results will not match these specifications. See [TN-TC01](#) for maximizing system performance.

² When using resistive heaters, stability can only be consistently achieved when setpoint temperatures are 10°C or more over ambient.

³ A fixed, non-volatile bias current can be configured with a custom sensor using remote command `CONST:THERM` with Firmware Versions 1.99 and 2.01 and later. See the [LAB Series Command Set User Guide](#) for more details.

OPERATING INSTRUCTIONS

WHAT'S IN THE BOX

- Temperature Controller Instrument
- Power Cable, type appropriate for final location
- 15 + 2 Male D-SUB plug and pins
- Two 3.15 A fuses are installed in the red fuse tray in the power entry module on the back panel
- USB Flash Drive, includes instrument documentation and LabVIEW Virtual Instrument

REQUIRED AND OPTIONAL EQUIPMENT

FOR SET UP

- Test load (optional) OR
- Thermoelectric or Resistive Heater and temperature sensor for feedback

COMPUTER REQUIREMENTS FOR REMOTE OPERATION ONLY (OPTIONAL)

Operating System: Windows XP SP2 or later

ESD INFORMATION

Before proceeding, it is critical that you take precautions to prevent electrostatic discharge (ESD) damage to the load. ESD damage can result from improper handling of sensitive electronics, and is easily preventable with simple precautions.

REMOTE OPERATION

The TC LAB can be controlled by a remote computer using the Command Set (see the [LAB Series Command Set User Guide](#)) or with a LabVIEW Virtual Instrument application (see the [Virtual Instrument User Guide](#)).

THEORY OF OPERATION

The TC LAB Series are high-current temperature controllers that deliver bidirectional current to Peltier Effect thermoelectric coolers (TE), or unidirectional current to resistive heaters (RH).

The fundamental operating principle is that the controller adjusts the output drive current in order to change the temperature of the sensor that is connected to the thermal load. The goal is to make the sensor temperature match the setpoint temperature, and then keep them equal in spite of changes to ambient conditions and variations in thermal load.

While output is enabled, the controller continuously compares the setpoint temperature and the actual sensor temperature. If there is a difference between the two, the controller adjusts the output current—thereby driving the TE or heater to heat or cool—until the difference is zero.

The controller includes features that help protect the load from damage, and also make it more versatile in a wide array of applications.

Current Limits: The adjustable current limits must be set correctly in order to avoid over-driving and damaging the TE or heater.

Control Loop: The controller employs a smart Proportional-Integral-Derivative control loop to adjust the drive current. The terms are user-adjustable and, when properly configured, will quickly settle the load temperature with minimal overshoot and ringing.

Voltage Limit: The voltage to the TE can be limited through remote commands.

Temperature Limits: Set high and low temperature limits to either report an over temperature condition at the load or use them to trigger a Shutdown signal to turn off a Laser Diode / QCL or other device driver to eliminate the active heat load and protect the device. Additionally, if temperature limits are exceeded, TE current will be disabled.

Sensor Disconnect/Failure Protection: If a short or open circuit is detected at the sensor, the output current is disabled.

TE Failure Protection: If a short is detected across the thermoelectric, the output current is also disabled.

IntelliTune: Wavelength's proprietary algorithm characterizes the TE / Sensor system's response to the TC LAB temperature controller and determines the optimal PID control coefficients. Then it automatically adjusts the PID control values as setpoint, tuning mode, or bias current are changed.

These instructions are for operating the TC LAB Series instrument. Fuses are provided and installed. We recommend using a test load until you are familiar with operation of the instrument.

REAR PANEL

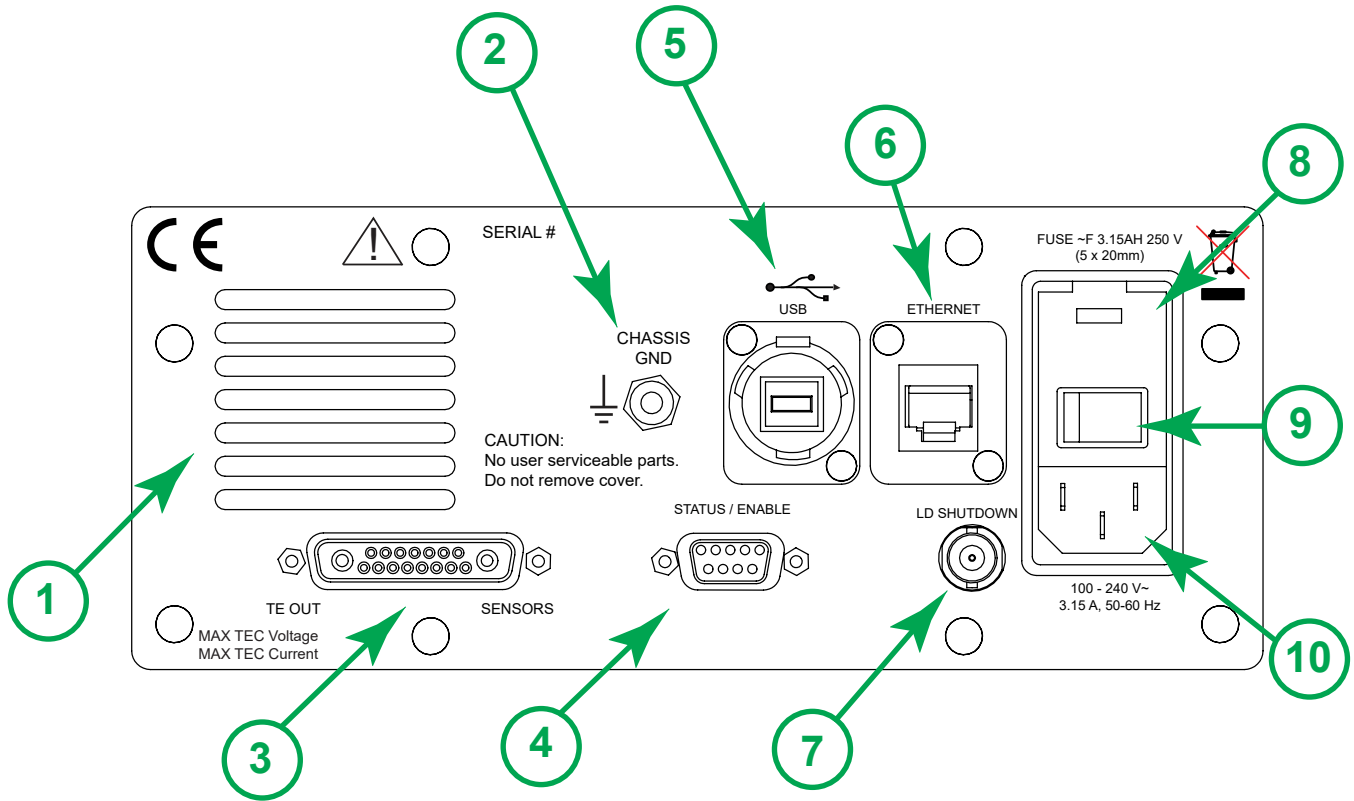

Figure 5. TC LAB Rear Panel

REAR PANEL FUNCTIONS

Table 3. Rear Panel Functions

	NAME	DESCRIPTION
1	Fan Vent	Do not block air flow.
2	Chassis Ground	Physical connection to chassis and electrical earth ground.
3	TE Out and Sensor	Thermoelectric connector and sensor input Female DB 15 + 2 D-SUB connector.
4	Status / Enable	9-Pin female D-SUB connector for remote enable, status monitors, and fan drive output.
5	USB	USB port, connection between instrument and a computer.
6	Ethernet	Ethernet port, connection between instrument and a computer or network.
7	Laser Diode Shutdown	BNC connector - link to Active Interlock on Laser Diode or QCL Driver.
8	Fuse Box	Removable fuse drawer.
9	AC Power Switch	AC power switch that powers the instrument.
10	AC Power Connector	IEC AC line input, IEC60320.

CONNECT THE POWER

On the back panel, insert the female end of the IEC AC power cable into the Power receptacle and then plug the male end into the AC power source.

NOTE: Place the TC LAB instrument at least 6" away from any wall to provide adequate ventilation and prevent overheating.

WIRE A SENSOR AND TEST LOAD

We recommend using a test load and simulated thermistor when configuring the TC LAB instrument. The thermistor test load simulates a 10 kΩ thermistor operating at 25°C.

Wire a 15 + 2 D-SUB plug to a test load and insert it into the **TE Out and Sensor D-SUB** port located on the back panel.

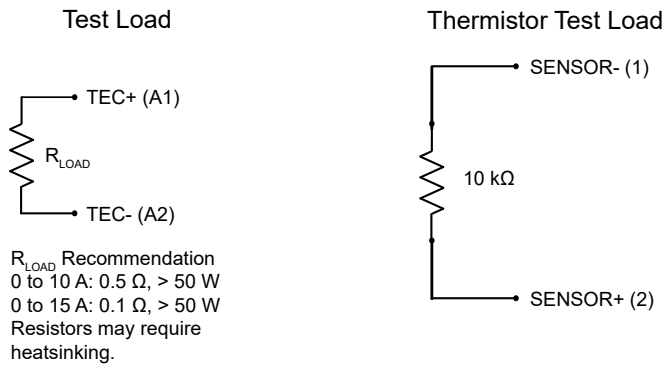

Figure 6. Test Load Wiring Schematic

Setting up this test load allows current to be driven to either the positive or negative limit. Choose units of resistance and change the setpoint above or below the 10 kΩ value. This confirms proper operation and direction of the current flow.

After practicing with a test load to gain comfort and proficiency with the operation of the instrument, wire the sensor and thermoelectric or resistive heater.

WIRE A SENSOR

Be sure to wire the sensor to the correct pins on the TE/Sensor D-SUB. Wiring depends on which type of sensor is used.

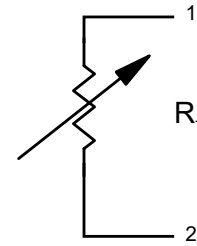

Figure 7. Thermistor Wiring Schematic

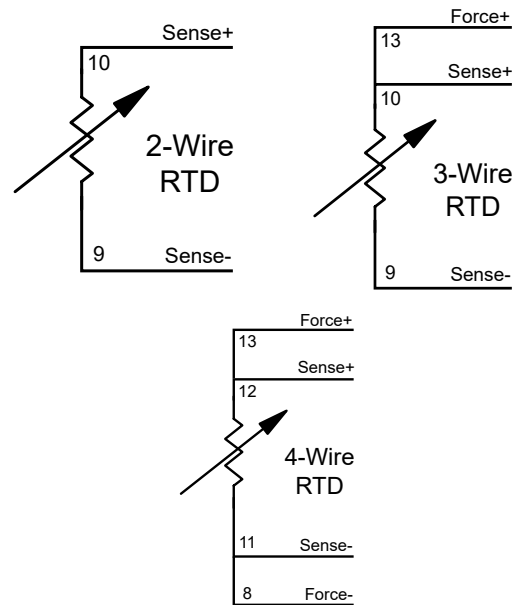

Figure 8. RTD Wiring Schematics

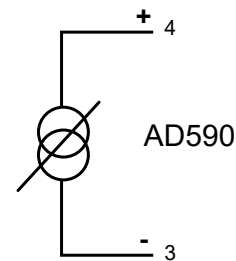

Figure 9. AD590 Wiring Schematic

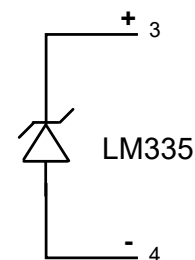

Figure 10. LM335 Wiring Schematic

WIRE AN AUXILIARY THERMISTOR SENSOR

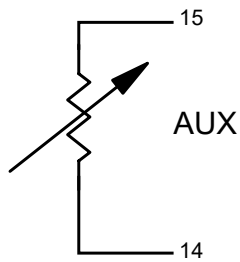

Figure 11. Auxiliary Sensor Schematic

An auxiliary sensor can be used to monitor the temperature of a secondary location in your system, such as the heatsink temperature. To do this, wire a 10 k Ω thermistor to Pins 14 and 15. The sensor temperature reports on the Monitor Screen.

WIRE A TEC OR RH LOAD

Wire a thermoelectric controller (TEC) or a resistive heater (RH) using Pins A1 and A2 on the 15+2 D-SUB.

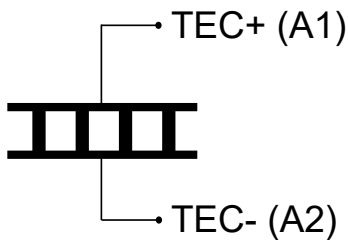

Figure 12. TEC Wiring Diagram

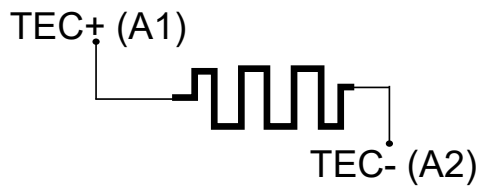

Figure 13. RH Wiring Diagram

FRONT PANEL

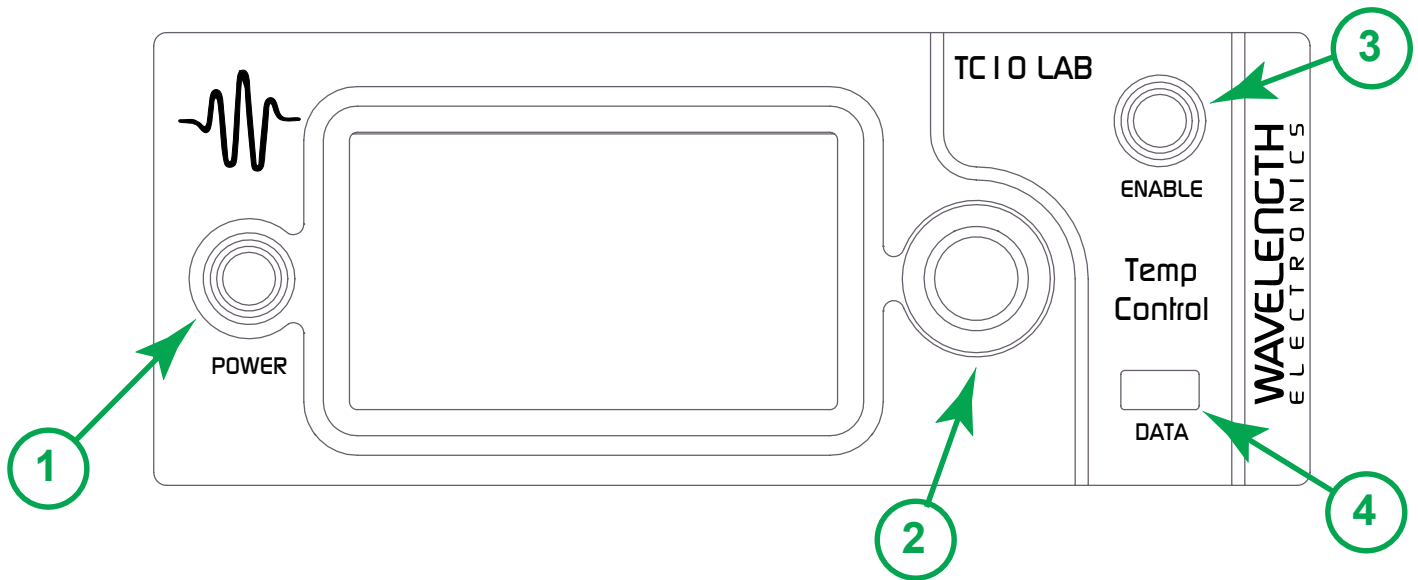

Figure 14. TC LAB Front Panel

FRONT PANEL FUNCTIONS

Table 4. Front Panel Functions

	NAME	DESCRIPTION
1	Power Button	Powers the application electronics. Glows blue when application electronics power is on and unit is operational, slow pulses blue when on Standby and only the back panel power switch is on.
2	Adjustment Knob	Turn to adjust the numeric values. Instrument beeps when values are set.
3	Enable Button	Allows instrument to deliver current to the thermoelectric load. Glows blue when current is enabled.
4	Data Port	USB flash drive, used to update the firmware or save data. This is not used for remote USB control of the instrument.

TEXT AND ICON COLOR KEY

TEXT

Text color indicates current state.

White, Green Uneditable field, for information only.

Blue Editable field, touch to select or toggle field (text highlights and changes color), adjust using either the touchscreen or adjustment knob. Instrument beeps and text returns to blue when values are set. If changes are not made, touch again to cancel selection.

ICONS

Icon color indicates current state.

Blue Screen is active.

Grey Screen is inactive, touch icon to access that screen.

TURN ON THE POWER

1. Press the **Power** switch on the back panel to the | position. The front panel power button light slowly pulses.
2. Press the **Power** button on the front panel, the button illuminates, touchscreen is activated, and the Control Screen is active.

*NOTE: Turning off front **Power** button powers down the application electronics and puts the unit into standby mode. Turning off rear **Power** switch powers down all electronics and some settings return to factory default.*

SET LIMITS



1. Press to access the Limit Screen.
2. Press **+ Limit Current**, **- Limit Current**, **Max Temp**, and/or **Min Temp** values and rotate the adjustment knob to change each value. The instrument will beep when set.

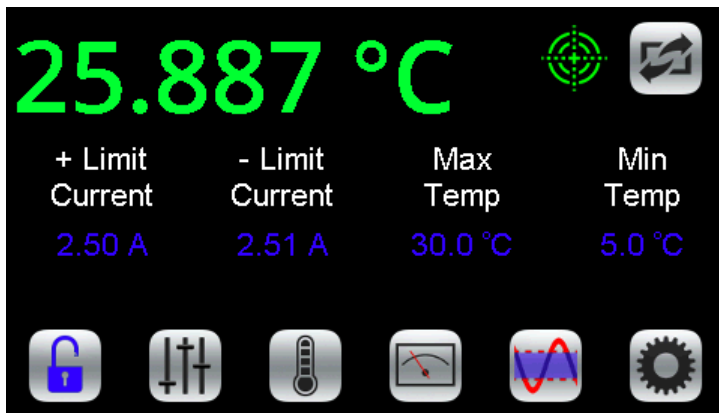

Figure 15. Limit Screen

NOTES:

- The **Limit Currents** should not exceed the damage current threshold of the thermoelectric. To operate a resistive heater, set one limit to **OFF**.
- The **Max Temp** and **Min Temp** can be set. If the actual sensor temperature exceeds these limits, this status is reported remotely so the user can take action.
- A TTL signal is sent from the LD Shutdown BNC to trigger an interlock in a laser diode or QCL driver, if the actual temperature exceeds the limit(s) specified. The factory default polarity is ACTIVE HI. The polarity can be changed through remote commands.
- The laser shutdown signal requires that a BNC to BNC cable is installed between the LD Shutdown on the TC LAB and the Active Lock on the QCL LAB.

SELECT A SENSOR

The sensor choice determines the sensor voltage to temperature relationship and which sensor pins are monitored on the 15+2 D-SUB.



1. Press to access the Sensor Screen.
2. Press the blue sensor name and turn the adjustment knob to cycle through the factory default sensor types or any user-defined sensors that were defined remotely.

The factory default sensors are:

- Thermistor, 5 k Ω 10 μ A
- Thermistor, 5 k Ω 100 μ A
- Thermistor, 10 k Ω 10 μ A
- Thermistor, 10 k Ω 100 μ A
- Thermistor, 20 k Ω 10 μ A
- Thermistor, 20 k Ω 100 μ A
- Thermistor, 50 k Ω 10 μ A
- Thermistor, 50 k Ω 100 μ A
- Thermistor, 100 k Ω 10 μ A
- RTD 2-wire, 100 Ω DIN
- RTD 2-wire, 1 k Ω DIN
- Linear IC Voltage Sensor
- Linear IC Current Sensor

The thermistor name includes the resistance at 25°C and the bias current base selection. See the thermistor datasheets for the resistance vs. temperature charts and Steinhart-Hart coefficients. The TC LAB auto-ranges the bias current by default. The current level in the sensor name merely defines the temperature range over which the sensor is calibrated. A fixed, non-volatile bias current can be configured with a custom sensor using remote command `CONST:THERM` with Firmware Versions 1.99 and 2.01 and later. See the [LAB Series Command Set User Guide](#) for more details.

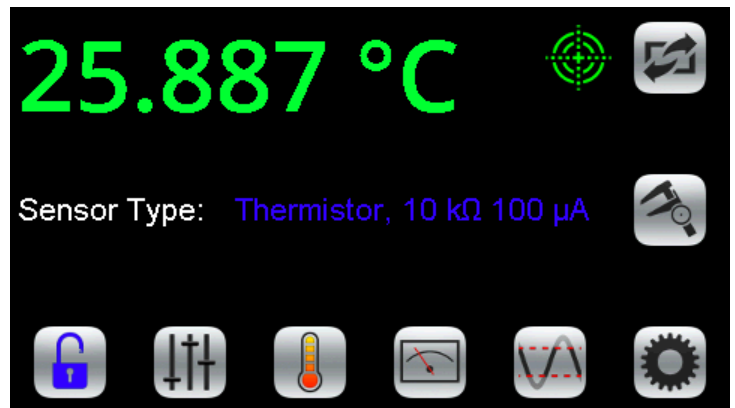

Figure 16. Sensor Screen

DISPLAY SENSOR CALIBRATION



Press to display the calibration coefficients for that sensor. User-defined sensor calibration values can be edited remotely. Set up a custom sensor using remote commands.

THERMISTOR:

Displays the Steinhart-Hart coefficients.

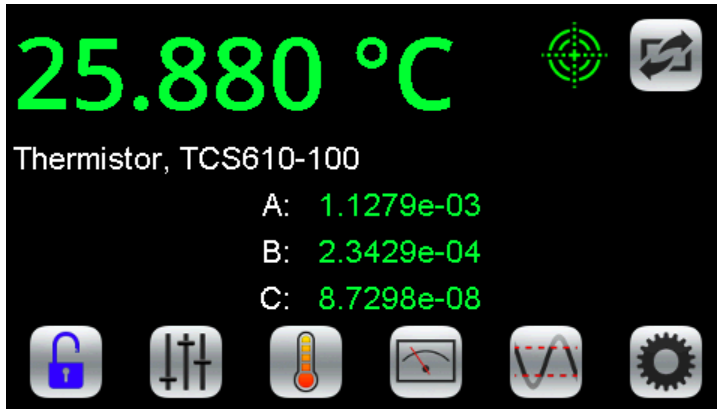

Figure 17. Thermistor Calibration Screen

RTD:

Displays the Standard Curve and the resistance at 0°C.

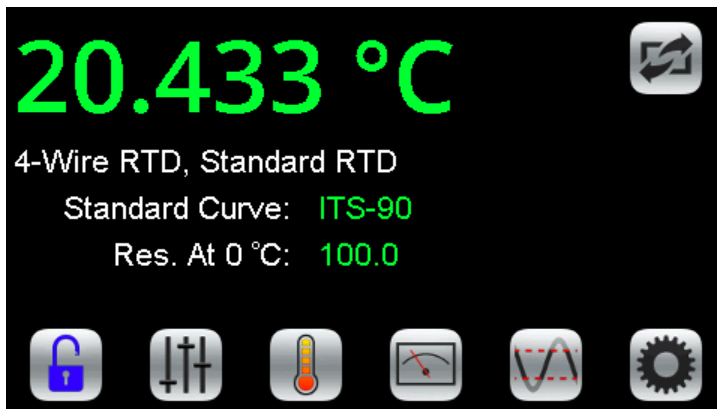

Figure 18. RTD Calibration Screen

LINEAR VOLTAGE OR LINEAR CURRENT:

Displays the slope and offset.

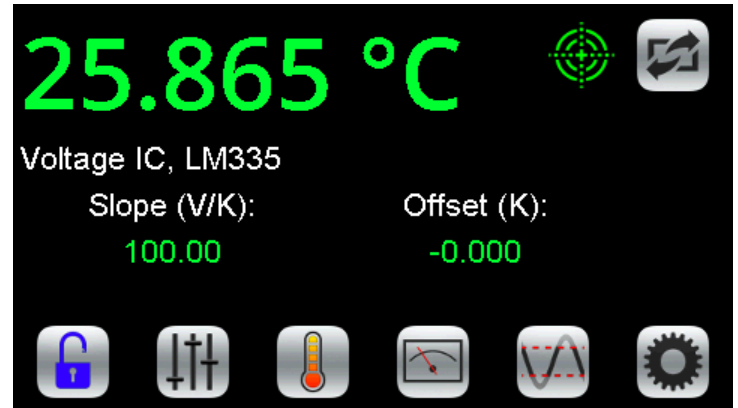

Figure 19. Linear Voltage Calibration Screen

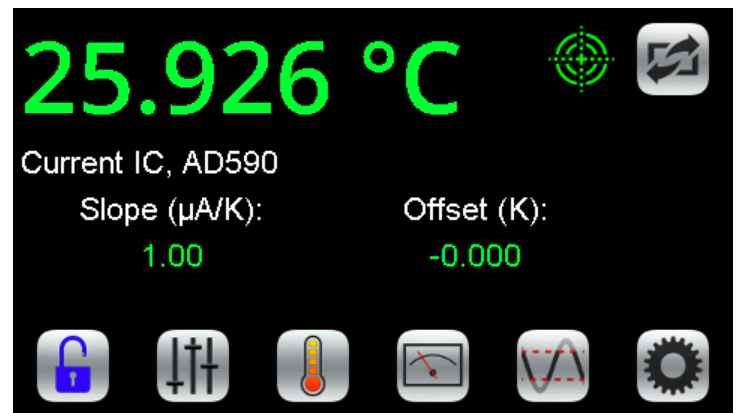

Figure 20. Linear Current Calibration Screen

ADJUST THE SETPOINT



1. Press to access the Control Screen.

NOTE: The actual temperature of the sensor is displayed in green and is not editable.

2. Press the **Setpoint** temperature value and turn the adjustment knob until the desired temperature is displayed.

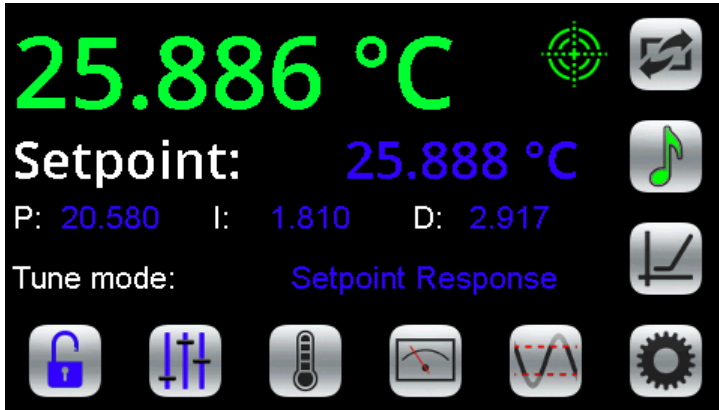

Figure 21. Control Screen

The Control Screen is also the location of the PID control parameters, IntelliTune, and the Temperature Scan function. To change any of the PID values, press the number and turn the adjustment knob until the desired value is displayed.

DISPLAY EXISTING CURRENT AND VOLTAGE VALUES



Press to access the Monitor Screen.

NOTE: Values on this screen cannot be changed and are for information only.

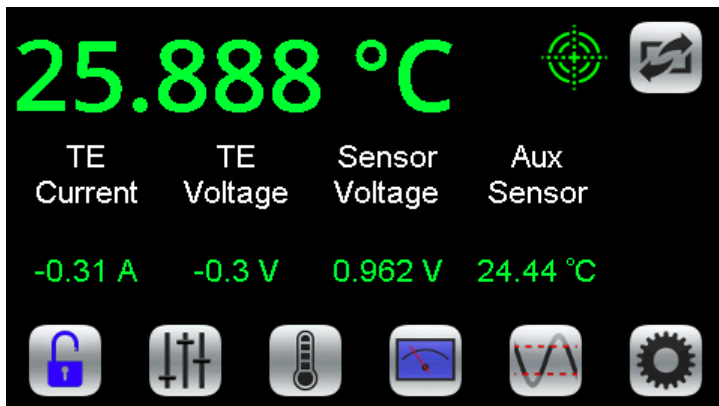

Figure 22. Monitor Screen

Signed thermoelectric current, TE voltage, and actual sensor voltage are displayed. The signal from the auxiliary sensor is converted to temperature using a 10 kΩ thermistor with 100 μA bias current calibration values.

ENABLE CURRENT

Press the **Enable** button. There is no delay before the button illuminates and the current flows.

Once the current is enabled, the actual temperature should move toward the setpoint temperature. (See the **Troubleshooting** section if it does not.)

Once the actual temperature is near the setpoint, a green target symbol is displayed to indicate that the actual temperature is within the specified tolerance window around the setpoint. Tolerance is set on the Settings Screen.

SCAN THE TEMPERATURE



1. On the Control Screen, press to access the Temperature Scan Screen.
2. Press the **Start Temp** value to select the temperature at which to start the scan. Turn the adjustment knob to change it.
3. Press the **Stop Temp** value to select the temperature at which to stop the scan.
4. Press the **Step Size** value to select the temperature interval at which to take a measurement.
5. Press the **Time Interval** value to select the amount of time to allow the temperature to settle.
6. Insert the USB flash drive in the USB DATA slot on the front panel.



7. Press the **Start Scan** button to start the scan. When finished, data is saved to the USB flash drive with the filename `tcscanxx.txt`, where `xx` starts at 00 and increments.



To stop mid-scan, press the red **Stop Scan** button. Any data collected during the aborted scan is saved to the USB flash drive.

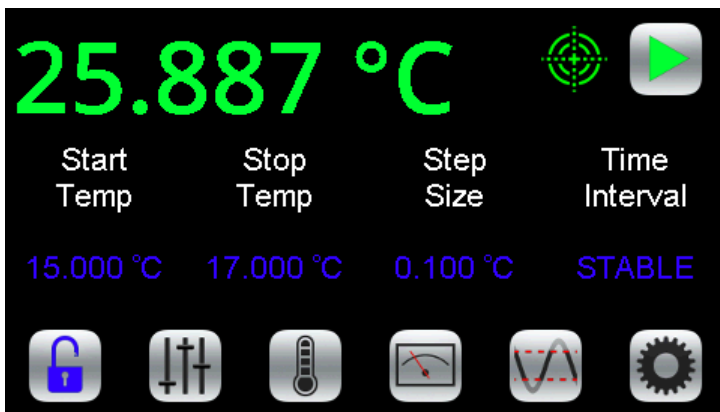

Figure 23. Scan Screen

The tolerance window can be very useful during a scan. Change the time interval to STABLE by rotating the knob counter clockwise. When the temperature reaches the setpoint \pm the tolerance window, a datapoint is recorded and the instrument increments the setpoint to the next indicated value. Ideally, the tolerance should be set very tight, much less than the scan step.

Time Offset, Setpoint, Actual Temp, Sensor Voltage, TE Current, and TE Voltage are stored to the data file.

Exiting the Scan screen aborts the scan. After the scan is complete, the current remains enabled and at the final scan setpoint.

To trigger a datapoint from another instrument at a given temperature, use the TTL TempStable output or the remote TEC Condition Register In Tolerance bit to trigger the measurement.

NOTE: Scan only in temperature mode. Resistance mode is not supported.

INTELLITUNE: INTELLIGENT AUTOTUNE

IntelliTune adjusts the PID coefficients, as well as the voltage limit.



1. Turn off the output current.
2. On the Control Screen, press Tune mode to choose either **Setpoint Response** or **Disturbance Rejection**.

Setpoint Response: This setting has a fast time to temperature and will overshoot.

Disturbance Rejection: This setting has a quick return to setpoint after stability is reached. It is best for pulsing laser or active loads, or if ambient temperature fluctuates.

Manual Tuning: Turns IntelliTune off.

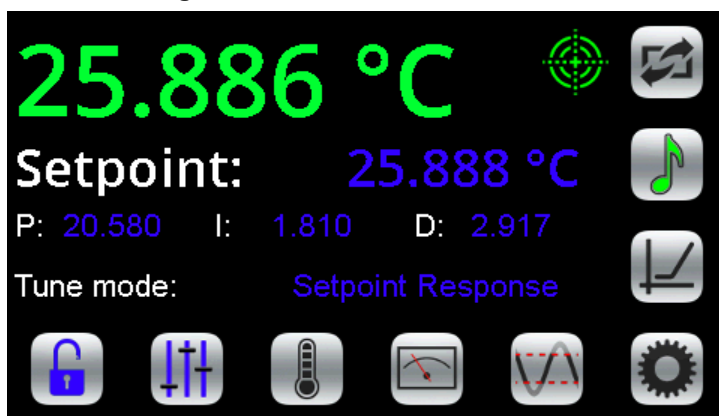

Figure 24. Control Screen

3. On the Limits screen, set Max/Min Temperature Limits.
4. Adjust the setpoint off ambient temperature by about 5°C.



5. Make sure the setpoint will not cause a sensor bias current change by choosing a setpoint between 0.25 to 12.075 V. The scan is completed at a single bias current level. For 10 k Ω thermistors the troublesome temperatures are around -23°C and 5°C. For 50 k Ω thermistors, the troublesome temperatures are around 7°C and 40°C.

6. Press to start a characterization scan.

NOTES:

- The process takes three sweeps and can take several minutes. The "note" icon fills with red to indicate a scan is in progress. If any portion of the icon is red and you want to stop the process, press the "note" icon to abort the session. If the session is aborted, the PID coefficients revert to the previously used coefficients.
- When the characterization process is complete, the new PID coefficients display and the icon reverts to green.
- Tune only in temperature mode. Resistance mode is not supported.
- A fixed, non-volatile bias current can be configured with a custom sensor using remote command `CONST:THERM` with Firmware Versions 1.99 and 2.01 and later. See the [LAB Series Command Set User Guide](#) for more details.

INTELLITUNE CONTINUOUSLY OPTIMIZES

Once a system is run through the IntelliTune process, the PID coefficients are adjusted as the setpoint, tune mode, or bias current is changed. Adjustments are made even if bias current changes or setpoint approaches ambient temperature. The IntelliTune setpoint does not need to match the system setpoint if the system setpoint is very high or very low. Run IntelliTune at a setpoint about 5°C away from ambient. IntelliTune stops if the sensor is changed or the tuning mode is set to Manual Tuning.

During an IntelliTune process, the current limits are set to 10% of the initial values. The limit icon glows red frequently. Current limits are restored after the scan is complete.

See Application Note [AN-TC13](#) for an in-depth exploration of IntelliTune.

SAVE OR RECALL SETTINGS



Press to access the Save/Recall Screen.



Under **Save Settings**, press the blue text to toggle through the **Profile** options, select one, and then press the Save icon.

The following operations settings are saved:

- Tune Mode
- Beeper Status
- Cable Resistance
- Current Limit, Negative
- Current Limit, Positive
- Display Brightness
- Proportional Gain
- Integrator Time Constant
- Differentiator Time Constant
- Scan Start Temperature
- Scan Temperature Step Size
- Scan Stop Temperature
- Scan Settling Period
- Sensor
- Temperature Setpoint
- High Temperature Limit
- Low Temperature Limit
- Tolerance

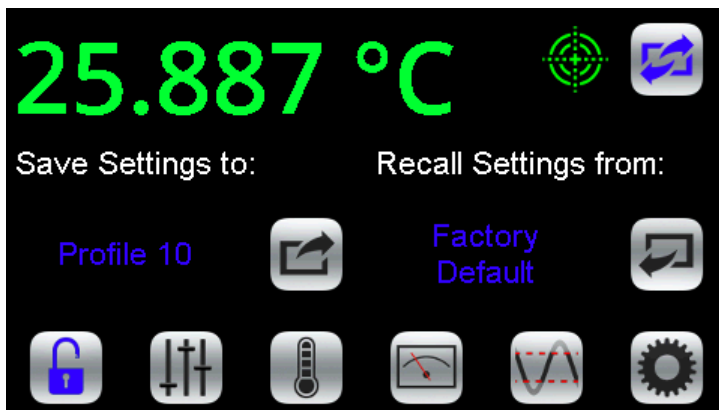

Figure 25. Save / Recall Screen

SETTINGS SCREEN



1. Press to access the Settings Screen.
2. Press the **Display** value to cycle through the display and control units available - Celcius (°C), Fahrenheit (°F), Kelvin (K) or Resistance.
3. Press the **Tolerance** value and turn the adjustment knob until the desired tolerance window is displayed. The target symbol will show on the front panel when the actual temperature is within the window defined by setpoint \pm the tolerance. The minimum tolerance is 0.01.
4. Move the slider bar on the touchscreen to change the **Display Brightness**.
5. Press the blue text to toggle the **Beeper** on-off setting.

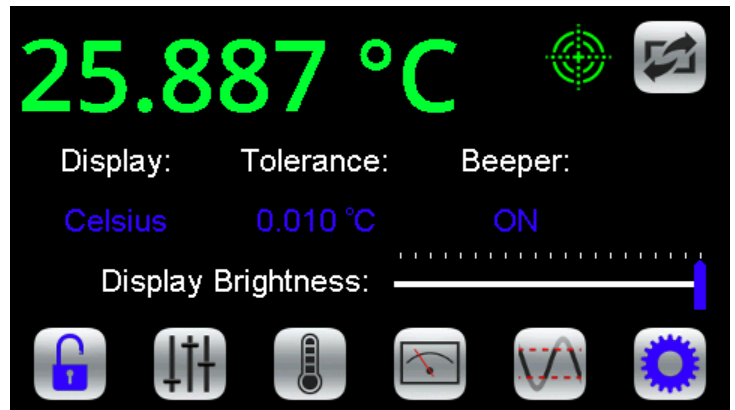

Figure 26. Settings Screen

LOCK OR UNLOCK SETTINGS (OPTIONAL)



Settings are not locked.

This is the default. Critical values set with the Adjustment knob can be locked. Press to lock the settings.



Settings are locked.

Press to unlock the settings.



Settings are locked and password protected.

Locked settings that are password protected can only be locked and unlocked using a remote computer.

USE THE STATUS/ENABLE D-SUB

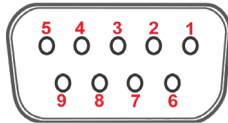

Figure 27. Status/Enable 9-pin D-SUB

REMOTE ENABLE INPUT (PINS 1 & 2)

This is a TTL signal that will override the front panel ENABLE button. The default polarity is ENABLE HIGH. Enter 0 V to disable the output regardless of the front panel enable button. An internal 100 k Ω pull up resistor means no external voltage is required for front panel operation with the default polarity. The polarity can be changed by remote command.

ENABLE STATUS (PINS 5 & 6)

This is a TTL signal that goes HI when the output current is enabled.

AT TEMPERATURE STATUS (PINS 5 & 7)

This is a TTL signal that goes HI when the actual temperature is within the window defined by setpoint \pm tolerance.

FAN CURRENT DRIVE (PINS 8 & 9)

This output will drive 12 V up to 0.5 A to power a fan for airflow across the thermoelectric and load. The auxiliary thermistor can monitor the temperature of the load heatsink.

CHANGE FUSES

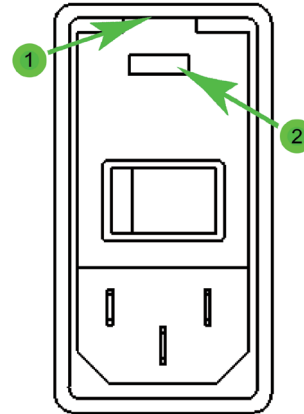

Figure 28. Fuse Box

1. On the back panel (see [page 9](#)), locate the Fuse Box.
2. Insert a small flathead screwdriver into the slot (1) at the top of the box and twist to open faceplate.
3. Install the fuses, one on each side of the receptacle, as shown in the image below, making sure the fuses contact the metal plate at the connector end of the fuse receptacle.

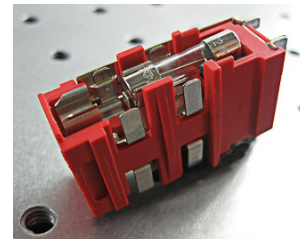

Figure 29. Fuse Placement

VOLTAGE	FUSES	PART NUMBER
100-240 V	3.15 A, 250 V, fast blow	Littelfuse 02163.15 HXP

4. Insert the fuse drawer in the fuse box, positioned as shown below. Press firmly to make sure the drawer is completely seated and flush with the box.

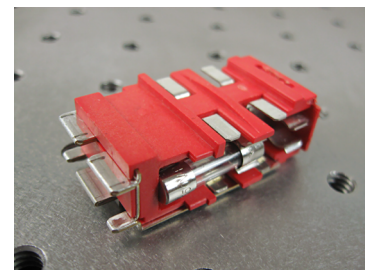

Figure 30. Fuse Box Direction

5. Close the faceplate, again pressing firmly until it is flush.

SHUTDOWN THE INSTRUMENT

If the Enable button is illuminated, current is still flowing to the test load. Before shutting down, the current needs to be turned off.

1. Press the **Enable** button. The button light will turn off and current to the test load will stop.
2. On the front panel, press the **Power** button. The touchscreen will go black but the button light slowly pulses blue to indicate that the back Power button is still on.

*NOTE: Turning off only the front **Power** button puts the instrument in Standby mode.*

3. On the back panel, press the **Power** switch to the **O** position. The instrument will shut down.

UPDATE THE FIRMWARE

The firmware can be updated on the instrument using a USB flash drive.

1. On the Wavelength Electronics website, navigate to one of the following download locations:
 - » The [Temperature Controller tab](#) on the Support Software Download page.
 - » Download & Design Tools tab on the [TC10 LAB](#) or [TC15 LAB](#) product pages.

NOTE: Use Firmware Version 2.01 and later for TC LAB Revision D.

Use Firmware Version 1.99 for TC LAB Revisions A - C. To determine the revision of the TC LAB, the third character in the Serial Number (**Figure 31**) indicates the instrument revision. In **Figure 31** the revision is A.

Installing the wrong revision of firmware will require recalibration at the factory.

2. Save the file to the hard drive of a computer.
3. Extract the files from the ZIP file downloaded from the website. This can be done in Windows by right clicking on the ZIP file, and clicking **Extract All**.
4. Copy the files to a USB flash drive.
5. Verify on the flash drive that the files are present. There should be a subfolder named TCxx-LAB, and a file named INSTALL.INI in the root of the flash drive.
6. Eject the flash drive from the computer.
7. Turn the instrument completely off at the rear panel.
8. Insert the USB flash drive into the front Data Port and turn on the rear power switch.
9. Follow the onscreen instructions to install the update. When notified on the screen that the installation is complete, remove the flash drive and then click OK to reboot the instrument.

DETERMINE WHICH FIRMWARE VERSION IS INSTALLED

With the rear and front panel power switches on, swipe the touchscreen from left to right to show the System Information Screen.



Figure 31. System Information Screen

TROUBLESHOOTING

Table 5. Troubleshooting

PROBLEM	POTENTIAL CAUSES	SOLUTIONS
Front panel Power button does not turn on	The button has been pushed on and off within 3 seconds.	The front panel Power button has a 3 second delay between when it is turned off and on in rapid succession. This is a safety mechanism to ensure there is no damage to either the TC instrument or the attached load.
	The rear panel switch is off.	Turn the rear panel switch to the on or position.
Temperature increases beyond the setpoint and will not come down	The TEC and heatsink are not adequately sized for the thermal load	The heat being generated by the load may be too great for the TEC to pump to the heatsink; a larger TEC or heatsink, or airflow may be needed. Consult Technical Note TN-TC01: Optimizing Thermoelectric Temperature Control Systems .
Temperature does not stabilize very well at setpoint	Poor thermal contact between components of the thermal load	Use thermal paste or washers between the load/TEC and TEC/heatsink interfaces. Make sure the temperature sensor is in good thermal contact with the load.
	Operating outside of the ideal region of the temperature sensor	The sensor type and bias current should be selected to maximize sensitivity at the target temperature. Thermistors provide the best performance, particularly for applications where a single setpoint temperature must be accurately maintained. For example, at 25°C a 10 kΩ thermistor has a sensitivity of 43 mV/°C, whereas an RTD sensor has a sensitivity of 4 mV/°C.
	Proportional control term is set too high	Run an IntelliTune scan.
	Derivative term is introducing noise.	Run an IntelliTune scan.
Using a resistive heater, temperature is slow to stabilize and is not within the specifications	Setpoint temperature is set too close to the ambient temperature	Set the temperature at least 10°C above ambient when using a resistive heater. A resistive heater is unable to precisely maintain temperatures near ambient because once the temperature overshoots the setpoint, the controller turns off and relies on ambient temperature to cool the load. If setting the temperature 10°C or more above ambient is not possible, then choose a thermoelectric, which can alternately heat and cool the load to maintain a more precise setpoint temperature.
	Airflow across load is inadequate.	Use a fan to blow air across the load to increase natural convection.
Temperature does not reach the setpoint	Insufficient current driven to the TEC or heater	Increase the current limit - but DO NOT exceed the specifications of the TEC or heater.
	The controller does not have sufficient compliance voltage to drive the TEC or heater	Check the thermoelectric voltage and determine if it is too close to the 15 V maximum. If it is, choose a lower voltage thermoelectric.
Actual temperature does not approach setpoint after output current is enabled	Thermoelectric wiring is reversed.	Reverse the leads to the thermoelectric.
	The thermoelectric is generating too much heat and has inadequate cooling	Install a larger heatsink or a fan to cool the heatsink.
I hear a beep and know there is an error, but nothing is displayed on the instrument screen	A remote command <i>REMERR</i> needs to be set to 1 to display errors	Connect the TC LAB instrument to a remote computer and write the <i>REMERR 1</i> command. See the Remote Command Set document for more information.
Can't clear an on-screen error message	The cause of the error may not have been fixed.	Press the enable button once. If the cause of the error is not corrected, the error message is displayed again.

PROBLEM	POTENTIAL CAUSES	SOLUTIONS
The Enable button does not turn on	The button has been turned on and off within 2 seconds.	The button cannot be pressed faster than every 2 seconds.
	The instrument experienced an internal fault. (See Error Messages .)	The instrument will remain disabled until manually powered off and then on using the rear panel power switch.
	The instrument heatsink temperature has exceeded 70°C.	Allow the instrument to cool down and then press the front panel power button.
	The front panel Power button is not on.	Press the Power button on the front panel to enable the display.
The instrument is on but the front panel display is blank	The instrument experienced an internal fault. (See Error Messages .)	Switch the back panel power button off and then on again, and turn the front panel power button on.
	The internal temperature has reached an unsafe level.	Allow the instrument to cool down and then switch the back panel power button off and then on again, and turn the front panel power button on.
	The front panel Power button is pulsing on and off in standby mode.	Press the Power button on the front panel to enable the display.
The date and time on my TC scan file are wrong		The TC LAB instrument does not have a realtime clock. When a TC scan file is created, the date and time stamp are randomly chosen.
The TC scan files are not in the order that they were created	Some files may have been deleted off of the USB flash drive.	When files are deleted off of the USB flash drive and new files are saved to it, the new files are given sequentially the names of the deleted files.
Unable to create new TC scans	There are too many files on the USB flash drive.	Delete files from the USB flash drive.
I can't find my TC scan files	TC scan files are named sequentially	If files have been deleted from the flash drive, any new files added are named sequentially and have the names of the deleted files.
The output switched off unexpectedly	The instrument detected an internal error. (See Error Messages .)	Switch the back panel power button off and then on again, and turn the front panel power button on.
	The internal temperature has exceeded 70°C.	Allow the instrument to cool down and then press the front panel power button.
My instrument doesn't show up in the list. (Remote Only)	Your instrument may not be turned on.	Power up the instrument and click Refresh on the Choose Instrument window.
	Your instrument may not be plugged in to the computer.	Check that either a USB or Ethernet cable is tightly connected to the instrument and to the computer.
	Your instrument may be on a different sub-net.	Add the sub-net to the Choose Instrument window and then click Refresh .
IntelliTune fails because of a sensor error	Sensor voltage may be too high or too low, which triggers a bias current change.	Choose a setpoint such that the sensor voltage will be between 0.25 V and 12.075 V. The sensor signal will be in range during all of the sweeps and not trigger a bias current change.
		Use the remote command <i>TEC:BIAS</i> to set a fixed sensor bias current. Review the TCS Series Thermistors Datasheet for temperature-resistance-voltage relationships.
IntelliTune stopped without an error message or updating the PID coefficients.	If a new sensor was chosen, it is possible that the Resistive Hi and Lo limits no longer apply.	Go to the Settings screen and change to Resistance Mode . On the Limit screen, update the RHI and RLO numbers to bracket the setpoint. Change back to Temperature Mode and retry IntelliTune scan.

PROBLEM	POTENTIAL CAUSES	SOLUTIONS
IntelliTune fails because of a “load short” error	VLIM may be too high.	Reduce the current limit and rerun IntelliTune to automatically reduce VLIM. Then reset the current limit and rerun the scan.
		Use remote command <i>TEC:VLIM 9</i> to set the VLIM to 9 V and then rerun IntelliTune.
		Put a resistor in series with the thermoelectric to increase the load compliance voltage.
Load Fault Error is triggered	A Load Fault Error may be falsely triggered when operating near maximum current and near maximum voltage.	Use remote command <i>TEC:VLIM 27</i> to limit the internal voltage supply to 27 V instead of the 28 V maximum.

ERROR MESSAGES

Table 6. Error Messages

To clear the error text, fix the cause and then press any icon or the Enable button.

ERROR	POTENTIAL CAUSES	SOLUTION
The USB flash drive is missing or not accessible. Please make sure that a USB flash drive is inserted into the front panel.	To run a local TC scan, a USB flash drive must be in place.	Insert a USB flash drive in the data port on the front panel.
The USB flash drive was removed. The scan has been aborted.	To run a local TC scan, a USB flash drive must be in place.	Insert a USB flash drive in the data port on the front panel
The internal temperature limit of the instrument has been exceeded. Output current has been disabled to protect the laser.	The ambient air temperature is too high for the instrument.	Reduce the ambient air temperature to 40°C or less.
The TC scan was canceled by the user.	The Stop button was pressed during the scan.	
Scan was canceled because output current is disabled.	The Enable button was pressed during a scan, cutting current to the load.	
An open circuit was detected at the load. Please verify the load and load connections.	The instrument cannot drive current through the load.	Make sure the A1 and A2 pins on the 15 + 2 D-SUB are connected to the thermoelectric or resistive heater.
A short circuit was detected at the load terminals. Please verify the load and load connections.	The instrument is detecting that there is no resistance where the load should be.	Make sure the A1 and A2 pins on the 15 + 2 D-SUB are connected to the thermoelectric or resistive heater.
An open circuit was detected at the sensor.	Sensor is wired to the wrong pins	Make sure the chosen sensor is properly wired.
A short circuit was detected at the sensor.		Make sure the chosen sensor is properly wired.
Shutdown at user limit	The actual temperature has exceeded one of the temperature limits and an LD Shutdown signal has been sent.	The temperature controller will continue to operate, but the TE current will be disabled. The active QCL or laser diode was shut down, if the LAB instruments were connected. The setpoint may be too close to the temperature limit. Overshoot is natural as the system is coming to temperature.
IntelliTune aborted – Starting actual temperature too close to setpoint.	To start IntelliTune, actual temperature cannot be close to setpoint.	Disable current, allow actual temperature to move away from setpoint, and restart IntelliTune.

**IF ANY OF THE ERRORS BELOW OCCUR,
PLEASE CONTACT WAVELENGTH TECHNICAL SUPPORT FOR FURTHER ASSISTANCE.**

- An internal error occurred while reading data from hardware. Please contact the factory for further assistance.
- A timeout occurred waiting for output. Make sure the load is connected and interlocks are satisfied.
- An internal error was detected. Please contact the factory for further assistance.
- A fault in the internal +5V supply was detected. Please contact the factory.
- A fault in the internal +15V supply was detected. Please contact the factory.
- A fault in the internal -15V supply was detected. Please contact the factory.
- A timeout occurred waiting for the internal load power supply to stabilize. Please contact the factory.
- A problem has been detected in the instrument power supply. Please contact the factory for further assistance.
- A current surge has been detected in the instrument. Output has been disabled to protect the laser.

TC LAB MECHANICAL SPECIFICATIONS

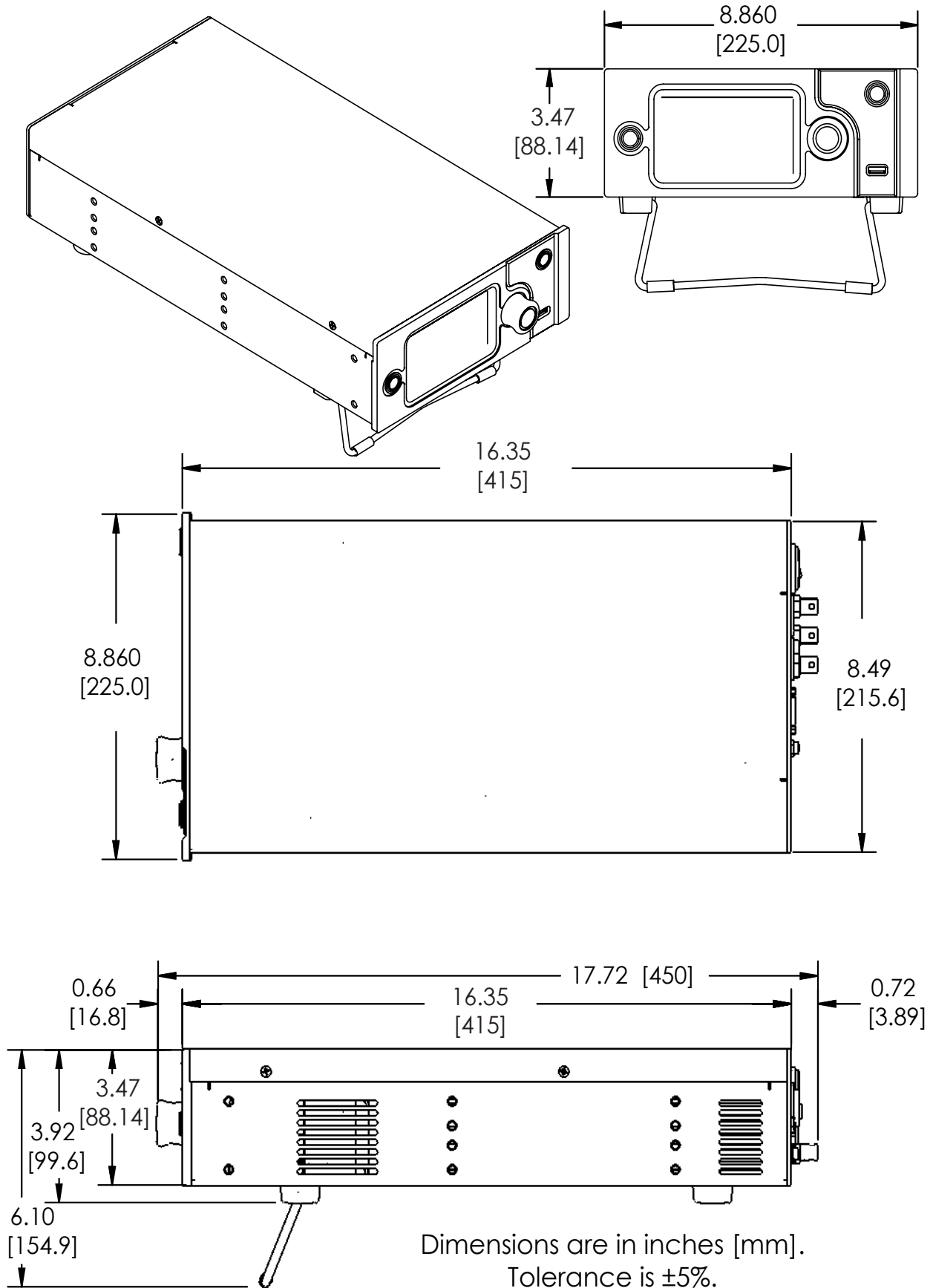

CABLING SPECIFICATIONS

WCB405 – STATUS/ENABLE DB-9 CABLE (NOT INCLUDED)

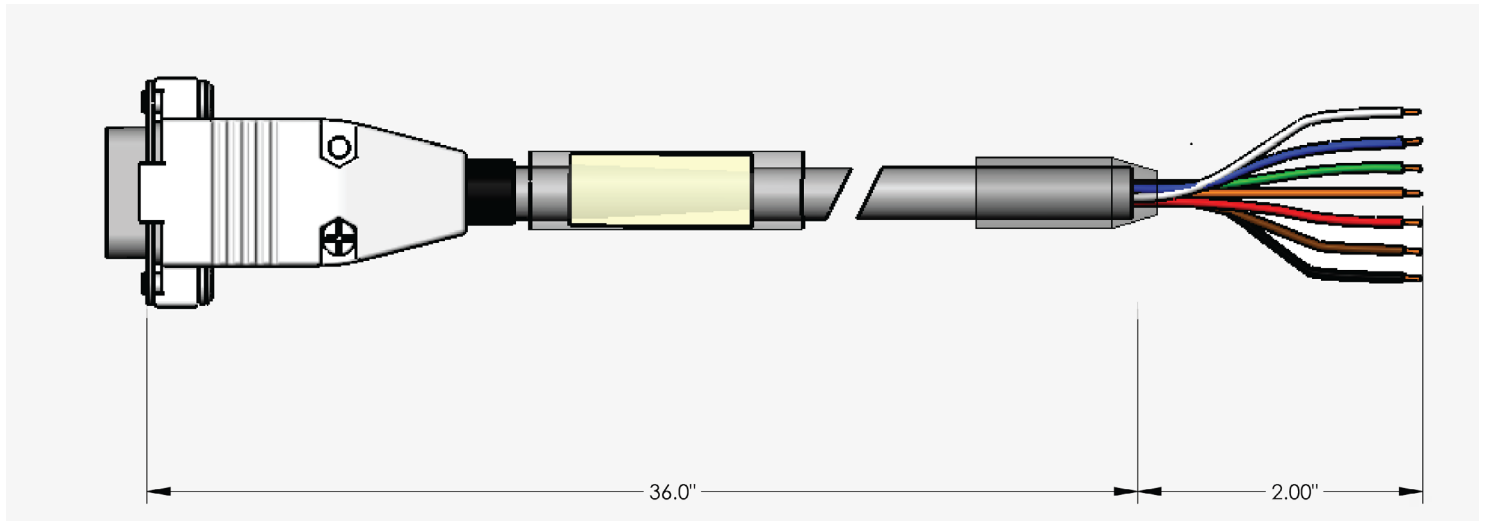

Figure 32. WCB405 Wiring Diagram (not included)

Table 7. WCB405 Pin/Wire Designation

PIN	DESCRIPTION	WIRE COLOR
1	REMOTE ENABLE INPUT (IN)	White
2	REMOTE ENABLE GROUND (GND)	Green
3	NO CONNECTION	
4	NO CONNECTION	
5	STATUS GROUND (GND)	Black
6	ENABLE STATUS	Blue
7	AT TEMP STATUS	Orange
8	FAN DRIVER OUTPUT	Red
9	FAN GROUND (GND)	Brown

WCB406 – TE/RH/SENSOR DB15+2 CABLE (NOT INCLUDED)

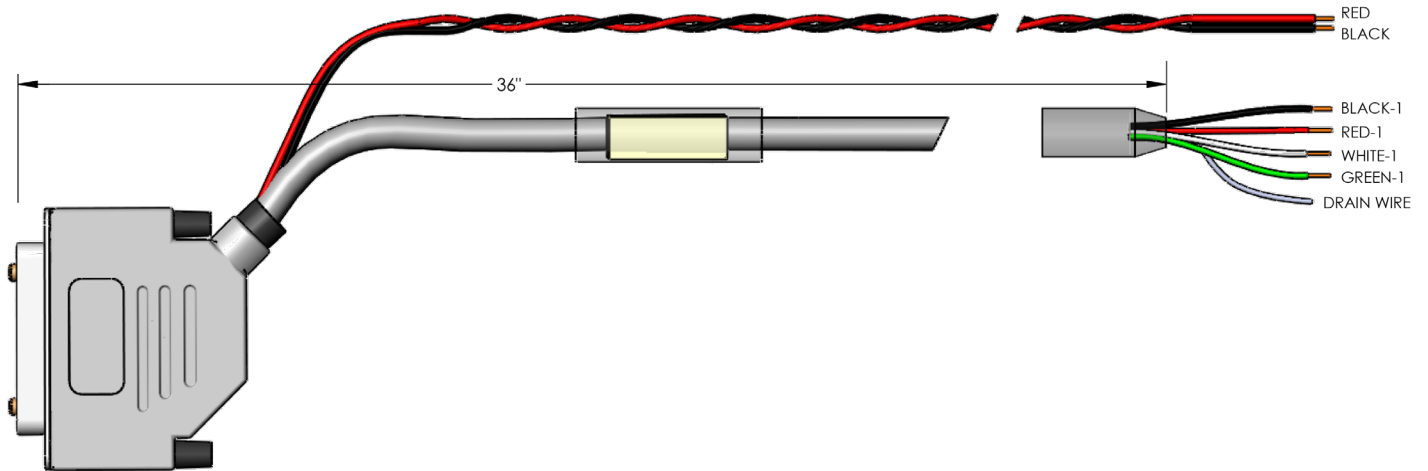
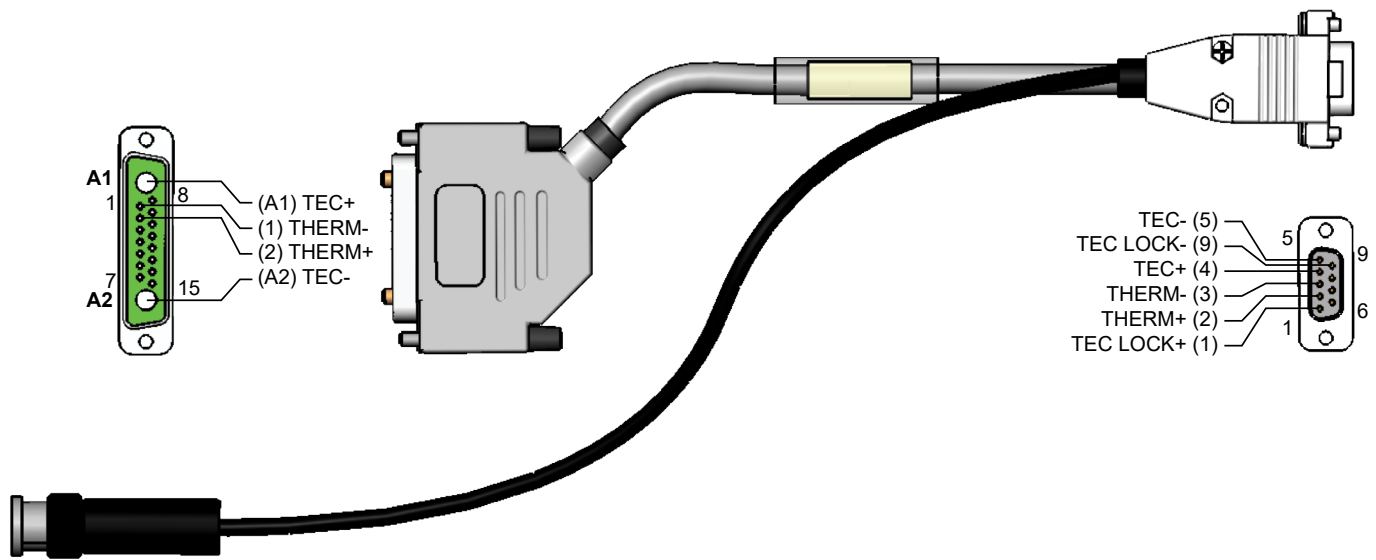

Figure 33. WCB406 Wiring Diagram (not included)

Table 8. WCB406 Pin/Wire Designation

PIN	DESCRIPTION	WIRE COLOR
A1	TEC OUTPUT +	Red
A2	TEC OUTPUT -	Black
1	THERMISTOR - (Negative)	Black - 1
2	THERMISTOR + (Positive)	Red - 1
3	NO CONNECTION	
4	NO CONNECTION	
5	NO CONNECTION	
6	NO CONNECTION	
7	NO CONNECTION	
8	NO CONNECTION	
9	NO CONNECTION	
10	NO CONNECTION	
11	NO CONNECTION	
12	NO CONNECTION	
13	NO CONNECTION	
14	AUXILIARY SENSOR - (Negative)	White - 1
15	AUXILIARY SENSOR + (Positive)	Green - 1

WCB315: TC LAB LDMOUNT CABLE (WITH INTERLOCK)



WCB319: TC LAB LDMOUNT CABLE (NO INTERLOCK)

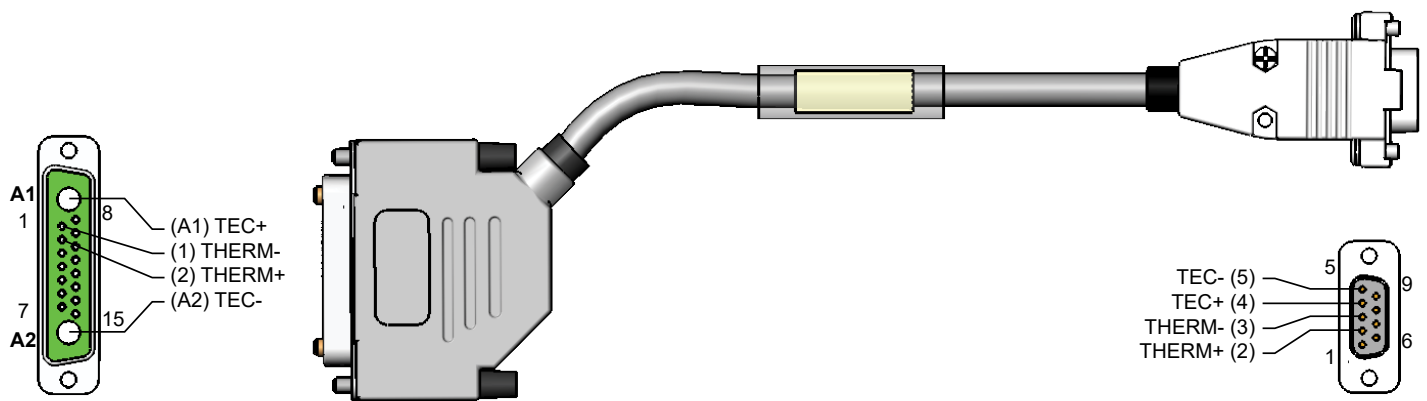

THE LDMOUNT HAS A CURRENT LIMIT OF 5 A. THE TC10 LAB AND TC15 LAB CAN BE USED WITH THE LDMOUNT AS LONG AS THE CURRENT LIMIT IS SET SUCH THAT NO MORE THAN 5 A WILL BE OUTPUT TO THE LDMOUNT. EXCEEDING 5 A CAN DAMAGE THE LDMOUNT AND LASER.

More recent revisions of the TC LAB have the current capacity to support the TEC Interlock function. The revision is labeled in the third character of the unit's serial number (LAX123456789). Please see the table below to determine which cable is appropriate for the model of TC LAB being used.

MODEL	REVISION	SUPPORTED CABLE
TC10 LAB	A	WCB319
TC10 LAB	B	WCB315 or WCB319
TC15 LAB	all	WCB315 or WCB319

All cables are 36 inches [914 mm] in length. All tolerances are $\pm 5\%$.

CE DECLARATION OF CONFORMITY

CONFORMING PRODUCTS

MODEL NUMBER	PRODUCT
TC15 LAB	15 A, 20 V Temperature Controller Instrument
TC10 LAB	10 A, 15 V Temperature Controller Instrument

DECLARATION

The undersigned hereby declares, on behalf of Wavelength Electronics, Inc. (Wavelength) of Bozeman, Montana, that the products listed in the table above, to which this Declaration applies, are in conformity with the provisions of:

APPLICABLE REGULATIONS

- European Council Directive 2014/30/EC (26 February, 2014) on Electromagnetic Compatibility, tested to:
 - » IEC 61000-3-2 and IEC 61000-3-3
 - » IEC 61000-4-2, IEC 61000-4-3, IEC 61000-4-4, IEC 61000-4-5, IEC 61000-4-6, and IEC 61000-4-8
- European Council Directive 2014/35/EC (26 February, 2014) on Low-Voltage Equipment Safety, tested to:
 - » IEC 61010-1
 - » IEC 61010-2-030 (Particular requirements for testing and measurement circuits)
- European Council Directive 2015/863/EU to amend Annex II to EU RoHS 2 (Directive 2011/65/EU) on Restriction of the use of certain hazardous substances in electrical and electronic equipment (recast) and the consolidated version of 24 June 2015
- Commission Delegated Directive (EU) 2016/585 of 12 February 2016 amending Annex IV to Directive 2011/65/EU

TECHNICAL FILE

The Technical Construction Files for the listed products, as required by this Declaration, are maintained at Wavelength corporate headquarters: 51 Evergreen Drive, Bozeman, Montana.



8-July-16

Mary Johnson, CEO

Date

WARRANTY & CERTIFICATION

LIFE SUPPORT POLICY

CERTIFICATION

Wavelength Electronics, Inc. (Wavelength) certifies that this product met its published specifications at the time of shipment. Wavelength further certifies that its calibration measurements are traceable to the United States National Institute of Standards and Technology, to the extent allowed by that organization's calibration facilities, and to the calibration facilities of other International Standards Organization members.

WARRANTY

This Wavelength product is warranted against defects in materials and workmanship for a period of one (1) year from date of shipment. During the warranty period, Wavelength will, at its option, either repair or replace products which prove to be defective. Warranty is void if label is removed from back panel.

WARRANTY SERVICE

For warranty service or repair, this product must be returned to the factory. An RMA is required for products returned to Wavelength for warranty service. The Buyer shall prepay shipping charges to Wavelength and Wavelength shall pay shipping charges to return the product to the Buyer upon determination of defective materials or workmanship. However, the Buyer shall pay all shipping charges, duties, and taxes for products returned to Wavelength from another country.

LIMITATIONS OF WARRANTY

The warranty shall not apply to defects resulting from improper use or misuse of the product or operation or any firmware downloads outside published specifications. Warranty for the TC LAB instrument is invalid if the instrument cover has been removed for any reason. No other warranty is expressed or implied. Wavelength specifically disclaims the implied warranties of merchantability and fitness for a particular purpose.

EXCLUSIVE REMEDIES

The remedies provided herein are the Buyer's sole and exclusive remedies. Wavelength shall not be liable for any direct, indirect, special, incidental, or consequential damages, whether based on contract, tort, or any other legal theory.

REVERSE ENGINEERING PROHIBITED

Buyer, End-User, or Third-Party Reseller are expressly prohibited from reverse engineering, decompiling, or disassembling this product.

NOTICE

The information contained in this document is subject to change without notice. Wavelength will not be liable for errors contained herein or for incidental or consequential damages in connection with the furnishing, performance, or use of this material. No part of this document may be translated to another language without the prior written consent of Wavelength.

SAFETY

There are no user-serviceable parts inside this product. Return the product to Wavelength Electronics for service and repair to ensure that safety features are maintained.

This important safety information applies to all Wavelength electrical and electronic products and accessories:

As a general policy, Wavelength Electronics, Inc. does not recommend the use of any of its products in life support applications where the failure or malfunction of the Wavelength product can be reasonably expected to cause failure of the life support device or to significantly affect its safety or effectiveness. Wavelength will not knowingly sell its products for use in such applications unless it receives written assurances satisfactory to Wavelength that the risks of injury or damage have been minimized, the customer assumes all such risks, and there is no product liability for Wavelength. Examples of devices considered to be life support devices are:

neonatal oxygen analyzers, nerve stimulators (for any use), auto-transfusion devices, blood pumps, defibrillators, arrhythmia detectors and alarms, pacemakers, hemodialysis systems, peritoneal dialysis systems, ventilators of all types, and infusion pumps as well as other devices designated as "critical" by the FDA.

The above are representative examples only and are not intended to be conclusive or exclusive of any other life support device.

CALIBRATION INTERVAL

The customer is responsible for determining calibration intervals; however, Wavelength Electronics recommends a calibration interval of two (2) years, beginning from the original date of manufacture. The instrument's calibration can be influenced by temperature, humidity, vibration and shock, as well as general wear over time. Extending the calibration interval can lead to operation outside of specifications and is not recommended.

TECHNICAL SUPPORT & CONTACT INFORMATION



WAVELENGTH ELECTRONICS

51 Evergreen Drive
Bozeman, Montana 59715
406-587-4910 (tel)
406-587-4911 (fax)

Sales & Tech Support
sales@teamWavelength.com
techsupport@teamWavelength.com

REVISION HISTORY

Document Number: TC10-LA400

REVISION	DATE	NOTES
K	Nov 2023	Added fixed bias current to custom sensors with updated firmware
L	Dec 2023	Added calibration interval